



Grayhill, Inc.

62S11-L9-PH

Zenkakiaren zenbakia:

Fabrikatzaileak / Marka:

Produktuaren Deskribapena

Fitxak:

RoHS egoera

Stock egoera

Ontziatik aurrera

Bidalketa Bidea

62S11-L9-PH

Grayhill, Inc.

ROTARY ENCODER OPTICAL 32PPR

 62S11-L9-PH.pdf

 Lead free / RoHS betez

1972 pcs stock

Hong Kong

DHL/Fedex/TNT/UPS/EMS

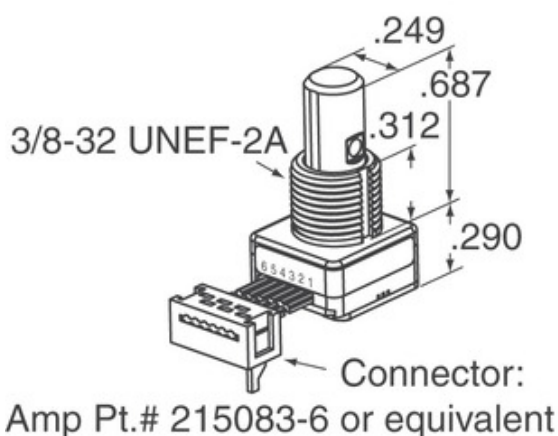
AURREKONTUEN ESKAERA

Irudia ordezkaritza izan daiteke. Ikusi produktuaren xehetasunetarako zehaztapenak.







62S11-L9-PHren zehaztapenak

ZENBAKIAREN ZENBAKIA	62S11-L9-PH
FABRIKATZAILEA	Grayhill, Inc.
DESKRIBAPENA	ROTARY ENCODER OPTICAL 32PPR
LEAD FREE STATUS / ROHS EGOERA	Lead free / RoHS betez
KOPURUA ESKURAGARRI	1972 pcs
DATUEN FITXA	 62S11-L9-PH.pdf
TENTSIOA - HORNIDURA	5V
AMAIERA ESTILOA	PC Pin
SERIES	62S
BIRAKETA-BIZITZA (ZIKLOAK)	1M
IRAULTZA BAKOITZEKO LEKALEAK	32
IRTEERAKO MOTA	Quadrature (Incremental)
BESTE IZENAK	62S11L9PH
ORIENTAZIO	Vertical
MUNTAKETA MOTA	PCB, Through Hole
HEZETASUNAREN SENTIKORTASUN MAILA (MSL)	1 (Unlimited)
LEAD FREE STATUS / ROHS EGOERA	Lead free / RoHS Compliant
KODETZAILE MOTA	Optical
DETENT	Yes
ALDATU ZEN	Yes
EKINTZA MOTA	1/4" Dia Flatted End

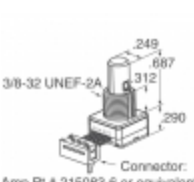
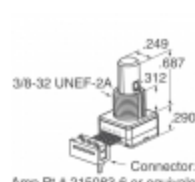
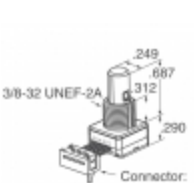
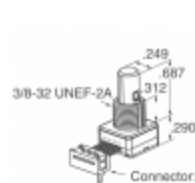
Erlazionatutako etiketak

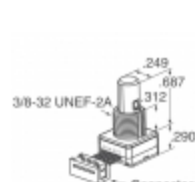
Grayhill, Inc. 62S11-L9-PH	62S11-L9-PH banatzailea	62S11-L9-PH hornitzailea
62S11-L9-PH Prezioa	62S11-L9-PH irudiak	62S11-L9-PH Irudia
62S11-L9-PH PDF fitxa	62S11-L9-PH Deskargatu fitxa	62S11-L9-PH Datasheet
62S11-L9-PH Stock	Erosi 62S11-L9-PH	Erosi Grayhill, Inc. 62S11-L9-PH
Grayhill, Inc. 62S11-L9-PH	Grayhill, Inc. hornitzailea	Grayhill, Inc. banatzailea
Grayhill, Inc. 62S11-L9-PH	Grayhill Inc. 62S11-L9-PH	

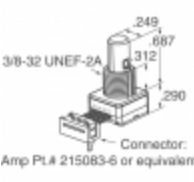
Produktu erlazionatuak

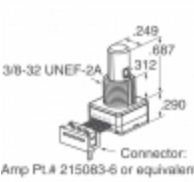
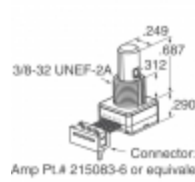
 <p>62S11-L9-020CH fabrikatzaileak: Grayhill, Inc. deskribapena: ROTARY ENCODER OPTICAL 32PPR Stockean: 2264 pcs</p> <p>RFQ</p>	 <p>62S11-M0-030CH fabrikatzaileak: Grayhill, Inc. deskribapena: ROTARY ENCODER OPTICAL 32PPR Stockean: 2151 pcs</p> <p>RFQ</p>
 <p>62S11-L9-040C fabrikatzaileak: Grayhill, Inc. deskribapena: ROTARY ENCODER OPTICAL 32PPR Stockean: 1938 pcs</p> <p>RFQ</p>	 <p>62S11-L9-020C fabrikatzaileak: Grayhill, Inc. deskribapena: ROTARY ENCODER OPTICAL 32PPR Stockean: 1773 pcs</p> <p>RFQ</p>
 <p>62S11-M0-040CH fabrikatzaileak: Grayhill, Inc. deskribapena: ROTARY ENCODER OPT 32PPR 2" CBL Stockean: 1915 pcs</p> <p>RFQ</p>	 <p>62S11-M0-020SH fabrikatzaileak: Grayhill, Inc. deskribapena: ROTARY ENCODER OPT 32PPR 2" CBL Stockean: 2051 pcs</p> <p>RFQ</p>
 <p>62S11-M0-050C fabrikatzaileak: Grayhill, Inc. deskribapena: ROTARY ENCODER OPT 32PPR 5" CBL Stockean: 2292 pcs</p> <p>RFQ</p>	 <p>62S11-M0-060C fabrikatzaileak: Grayhill, Inc. deskribapena: ROTARY ENCODER OPT 32PPR 6" CBL Stockean: 2289 pcs</p> <p>RFQ</p>
 <p>62S11-M0-020C fabrikatzaileak: Grayhill, Inc. deskribapena: ROTARY ENCODER OPT 32PPR 2" CBL Stockean: 1812 pcs</p> <p>RFQ</p>	 <p>62S11-L5-PH fabrikatzaileak: Grayhill, Inc. deskribapena: ROTARY ENCODER OPTICAL 32PPR Stockean: 2218 pcs</p> <p>RFQ</p>
 <p>62S11-L9-020SH fabrikatzaileak: Grayhill, Inc. deskribapena: ROTARY ENCODER OPTICAL 32PPR Stockean: 1952 pcs</p> <p>RFQ</p>	 <p>62S11-L9-020S fabrikatzaileak: Grayhill, Inc. deskribapena: ROTARY ENCODER OPTICAL 32PPR Stockean: 2134 pcs</p> <p>RFQ</p>

Copyright © 2020 Osagai elektronikoen banatzaile fidagarria

E-mail: Info@infinity-electronic.com

Helbidea: 17F, Gaylord Merkataritza Eraikina, 114-118 Lockhart Road, Wan Chai, Hong Kong

