



Grayhill, Inc.

62S11-L0-PHV

Zenkakiaren zenbakia:

Fabrikatzaileak / Marka:

Produktuaren Deskribapena

Fitxak:

RoHS egoera

Stock egoera

Ontziatik aurrera

Bidalketa Bidea

62S11-L0-PHV

Grayhill, Inc.

ROTARY ENCODER OPTICAL 32PPR

 62S11-L0-PHV.pdf

 Lead free / RoHS betez

1991 pcs stock

Hong Kong

DHL/Fedex/TNT/UPS/EMS

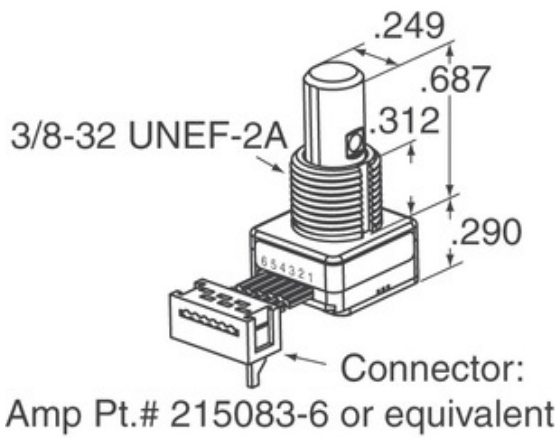

Irudia ordezkaritza izan daiteke. Ikusi produktuaren xehetasunetarako zehaztapenak.



62S11-L0-PHVren zehaztapenak

ZENBAKIAREN ZENBAKIA	62S11-L0-PHV
FABRIKATZAILEA	Grayhill, Inc.
DESKRIBAPENA	ROTARY ENCODER OPTICAL 32PPR
LEAD FREE STATUS / ROHS EGOERA	Lead free / RoHS betez
KOPURUA ESKURAGARRI	1991 pcs
DATUEN FITXA	 62S11-L0-PHV.pdf
TENTSIOA - HORNIDURA	5V
AMAIERA ESTILOA	PC Pin
SERIES	62S
BIRAKETA-BIZITZA (ZIKLOAK)	1M
IRAULTZA BAKOITZEKO LEKALEAK	32
IRTEERAKO MOTA	Quadrature (Incremental)
BESTE IZENAK	62S11L0PHV
ORIENTAZIO	Vertical
MUNTAKETA MOTA	PCB, Through Hole
HEZETASUNAREN SENTIKORTASUN MAILA (MSL)	1 (Unlimited)
LEAD FREE STATUS / ROHS EGOERA	Lead free / RoHS Compliant
KODETZAILE MOTA	Optical
DETENT	Yes
ALDATU ZEN	No
EKINTZA MOTA	1/4" Dia Flatted End

Erlazionatutako etiketak

Grayhill, Inc. 62S11-L0-PHV	62S11-L0-PHV banatzailea	62S11-L0-PHV hornitzailea
62S11-L0-PHV Prezioa	62S11-L0-PHV irudiak	62S11-L0-PHV Irudia
62S11-L0-PHV PDF fitxa	62S11-L0-PHV Deskargatu fitxa	62S11-L0-PHV Datasheet
62S11-L0-PHV Stock	Erosi 62S11-L0-PHV	Erosi Grayhill, Inc. 62S11-L0-PHV
Grayhill, Inc. 62S11-L0-PHV	Grayhill, Inc. hornitzailea	Grayhill, Inc. banatzailea
Grayhill, Inc. 62S11-L0-PHV	Grayhill Inc. 62S11-L0-PHV	

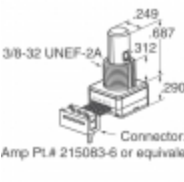
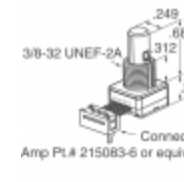
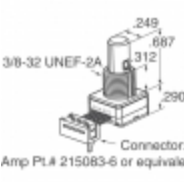
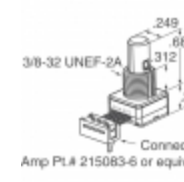
Produktu erlazioatuak

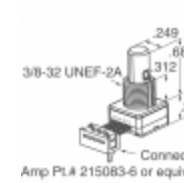
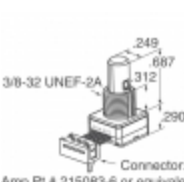
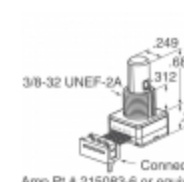
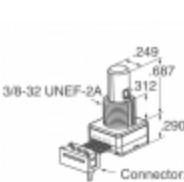
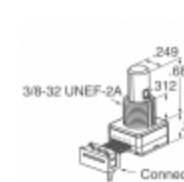
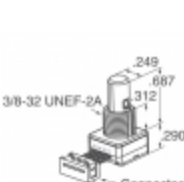
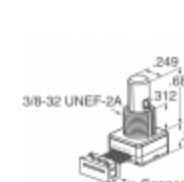
 <p>62S11-L4-030S fabrikatzaileak: Grayhill, Inc. deskribapena: ROTARY ENCODER OPTICAL 32PPR Stockean: 1829 pcs</p> <p>RFQ</p>	 <p>62S11-L4-025SH fabrikatzaileak: Grayhill, Inc. deskribapena: ROTARY ENCODER OPTICAL 32PPR Stockean: 2264 pcs</p> <p>RFQ</p>
 <p>62S11-L0-060CH fabrikatzaileak: Grayhill, Inc. deskribapena: ROTARY ENCODER OPTICAL 32PPR Stockean: 1935 pcs</p> <p>RFQ</p>	 <p>62S11-L0-055C fabrikatzaileak: Grayhill, Inc. deskribapena: ROTARY ENCODER OPTICAL 32PPR Stockean: 1995 pcs</p> <p>RFQ</p>
 <p>62S11-L4-020C fabrikatzaileak: Grayhill, Inc. deskribapena: ROTARY ENCODER OPTICAL 32PPR Stockean: 2162 pcs</p> <p>RFQ</p>	 <p>62S11-L0-PH fabrikatzaileak: Grayhill, Inc. deskribapena: ROTARY ENCODER OPTICAL 32PPR Stockean: 2460 pcs</p> <p>RFQ</p>
 <p>62S11-L4-020S fabrikatzaileak: Grayhill, Inc. deskribapena: ROTARY ENCODER OPT 32PPR 2" CBL Stockean: 1879 pcs</p> <p>RFQ</p>	 <p>62S11-L0-P fabrikatzaileak: Grayhill, Inc. deskribapena: ROTARY ENCODER OPTICAL 32PPR Stockean: 2100 pcs</p> <p>RFQ</p>
 <p>62S11-L0-060SH fabrikatzaileak: Grayhill, Inc. deskribapena: ROTARY ENCODER OPTICAL 32PPR Stockean: 2073 pcs</p> <p>RFQ</p>	 <p>62S11-L0-060S fabrikatzaileak: Grayhill, Inc. deskribapena: ROTARY ENCODER OPTICAL 32PPR Stockean: 2241 pcs</p> <p>RFQ</p>
 <p>62S11-L4-040C fabrikatzaileak: Grayhill, Inc. deskribapena: ROTARY ENCODER OPTICAL 32PPR Stockean: 2290 pcs</p> <p>RFQ</p>	 <p>62S11-L4-040CH fabrikatzaileak: Grayhill, Inc. deskribapena: ROTARY ENCODER OPTICAL 32PPR Stockean: 1716 pcs</p> <p>RFQ</p>

Copyright © 2020 Osagai elektronikoen banatzaile fidagarria

E-mail: Info@infinity-electronic.com

Helbidea: 17F, Gaylord Merkataritza Eraikina, 114-118 Lockhart Road, Wan Chai, Hong Kong

