



GaAs MMIC LOW NOISE AMPLIFIER, 5 - 6 GHz

Typical Applications

The HMC320MS8G(E) is ideal for:

- UNII
- HiperLAN

Features

- Selectable Functionality: LNA, Driver, or LO Buffer Amp
- Adjustable Input IP3 Up to +10 dBm
- +3V Operation
- Ultra Small 8 Lead MSOP: 14.8 x 14.8 x 1 mm

Functional Diagram

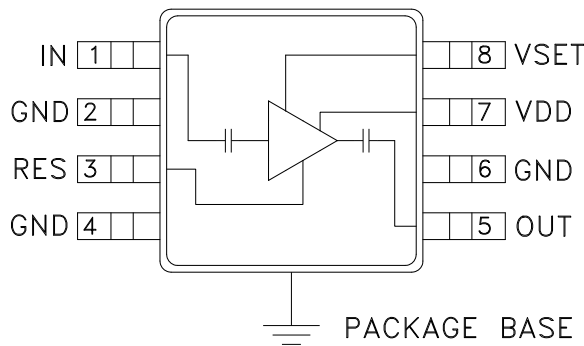

General Description

The HMC320MS8G & HMC320MS8GE are low cost C-band fixed gain Low Noise Amplifiers (LNA). The HMC320MS8G & HMC320MS8GE operate using a single positive supply that can be set between +3V and +5V. With +3V bias, the LNA provides a noise figure of 2.5 dB, 1 dB gain and better than 10 dB return loss across the UNII band. The HMC320MS8G & HMC320MS8GE also feature an adaptive biasing that allows the user to select the optimal P1dB performance for their system using an external set resistor on the “RES” pin. P1dB performance can be set between a range of +1 dBm to +13 dBm. The low cost LNA uses an 8-leaded MSOP ground base surface mount plastic package, which occupies less than 14.8 mm².

Electrical Specifications, $T_A = +25^\circ\text{C}$, $V_{dd} = +3\text{V}$

Parameter	Low Power* (VSET = 0V, I _{dd} = 7 mA)			Medium Power* (VSET = 3V, I _{dd} = 25 mA)			High Power* (VSET = 3V, I _{dd} = 40 mA)			Units
	Min.	Typ.	Max.	Min.	Typ.	Max.	Min.	Typ.	Max.	
Frequency Range	5 - 6			5 - 6			5 - 6			GHz
Gain	8	10	16	8	12	16	9	13	16	dB
Gain Variation over Temperature		0.025	0.035		0.025	0.035		0.025	0.035	dB/°C
Gain Flatness		±0.5			±1.0			±1.5		dB
Noise Figure		2.7	3.8		2.5	3.8		2.6	3.8	dB
Input Return Loss	4	10		4	10		4	10		dB
Output Return Loss	7	13		10	18		10	20		dB
Output Power for 1 dB Compression (P1dB)	-4	-1		6	9		9	12		dBm
Input Third Order Intercept Point (IIP3)	-3	1		4	8		6	10		dBm
Supply Current (I _{dd})		7			25			40		mA

* R_{BIAS} resistor value sets current. See adaptive biasing application note.

Information furnished by Analog Devices is believed to be accurate and reliable. However, no responsibility is assumed by Analog Devices for its use, nor for any infringements of patents or other rights of third parties that may result from its use. Specifications subject to change without notice. No license is granted by implication or otherwise under any patent or patent rights of Analog Devices. Trademarks and registered trademarks are the property of their respective owners.

For price, delivery, and to place orders: Analog Devices, Inc., One Technology Way, P.O. Box 9106, Norwood, MA 02062-9106
 Phone: 781-329-4700 • Order online at www.analog.com
 Application Support: Phone: 1-800-ANALOG-D

HMC320* PRODUCT PAGE QUICK LINKS

Last Content Update: 02/23/2017

COMPARABLE PARTS

View a parametric search of comparable parts.

EVALUATION KITS

- HMC320MS8G Evaluation Board

DOCUMENTATION

Data Sheet

- HMC320 Data Sheet

TOOLS AND SIMULATIONS

- HMC320 S-Parameter

REFERENCE MATERIALS

Quality Documentation

- HMC Legacy PCN: MS##, MS##E and MS##G,MS##GE packages - Relocation of pre-existing production equipment to new building
- Package/Assembly Qualification Test Report: MS8G (QTR: 2014-00393)
- PCN: MS, QS, SOT, SOIC packages - Sn/Pb plating vendor change
- Semiconductor Qualification Test Report: MESFET-F (QTR: 2013-00247)

DESIGN RESOURCES

- HMC320 Material Declaration
- PCN-PDN Information
- Quality And Reliability
- Symbols and Footprints

DISCUSSIONS

View all HMC320 EngineerZone Discussions.

SAMPLE AND BUY

Visit the product page to see pricing options.

TECHNICAL SUPPORT

Submit a technical question or find your regional support number.

DOCUMENT FEEDBACK

Submit feedback for this data sheet.



GaAs MMIC LOW NOISE AMPLIFIER, 5 - 6 GHz

**Broadband Gain & Return Loss
Medium Power Bias**

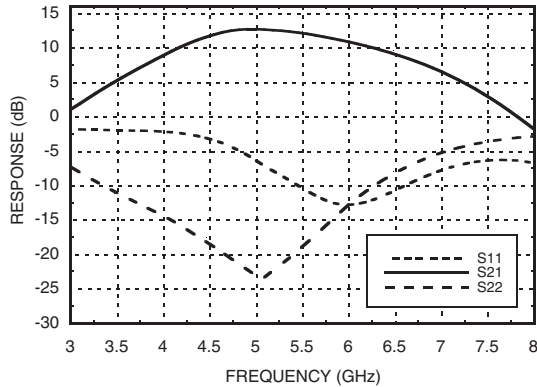

Gain @ Three Bias Conditions

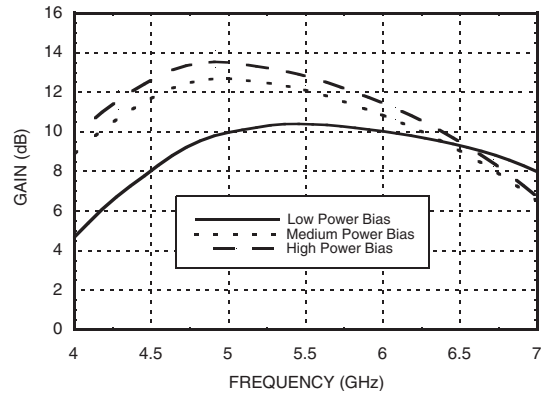

**Gain vs. Temperature
Medium Power Bias**

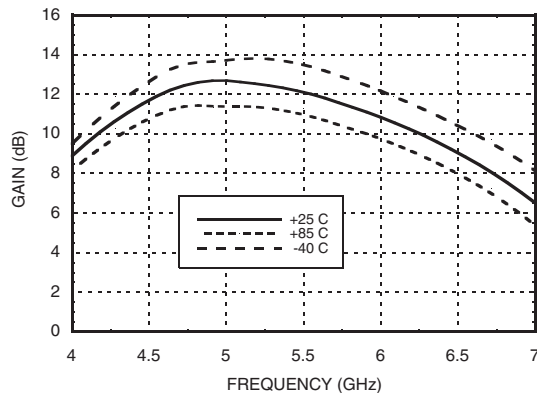

**Input Return Loss
@ Three Bias Conditions**

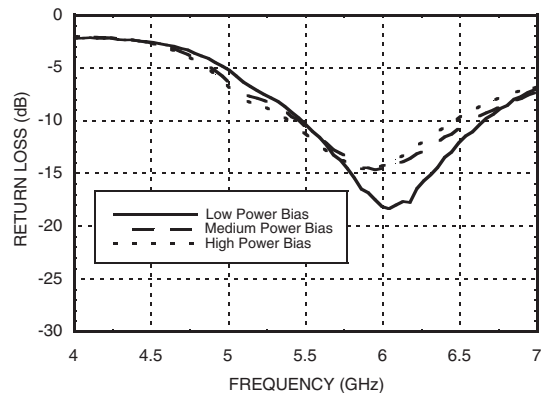

**Noise Figure vs. Temperature
Medium Power Bias**

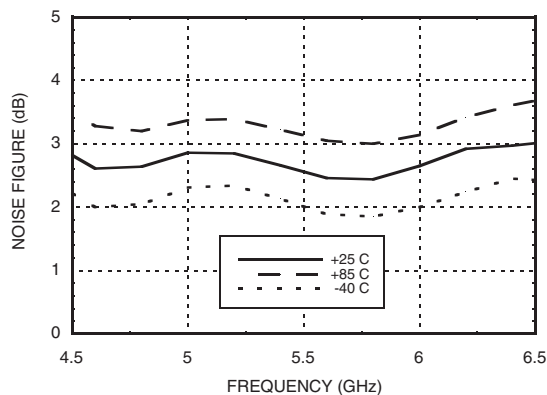

**Output Return Loss
@ Three Bias Conditions**

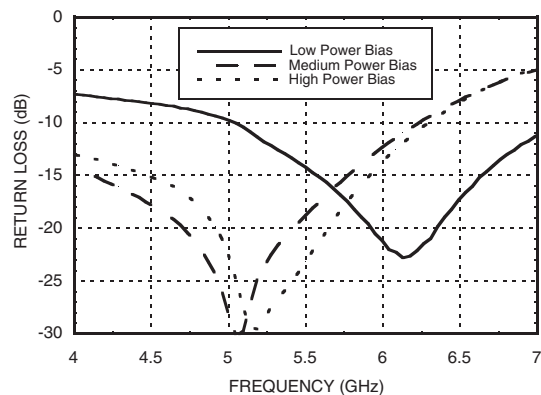

Information furnished by Analog Devices is believed to be accurate and reliable. However, no responsibility is assumed by Analog Devices for its use, nor for any infringements of patents or other rights of third parties that may result from its use. Specifications subject to change without notice. No license is granted by implication or otherwise under any patent or patent rights of Analog Devices. Trademarks and registered trademarks are the property of their respective owners.

For price, delivery, and to place orders: Analog Devices, Inc., One Technology Way, P.O. Box 9106, Norwood, MA 02062-9106 Phone: 781-329-4700 • Order online at www.analog.com Application Support: Phone: 1-800-ANALOG-D



GaAs MMIC LOW NOISE AMPLIFIER, 5 - 6 GHz

Noise Figure @ Three Bias Conditions

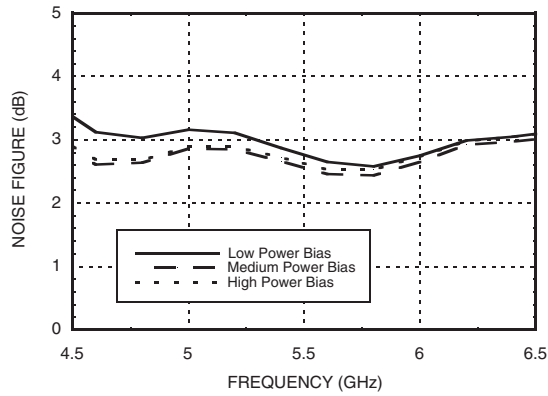

Input IP3 @ Three Bias Conditions

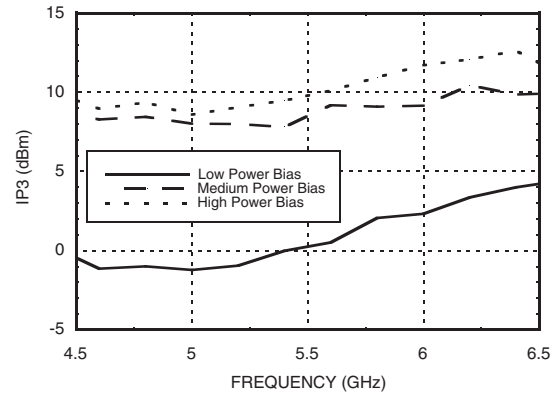

Output 1dB Compression @ Three Bias Conditions

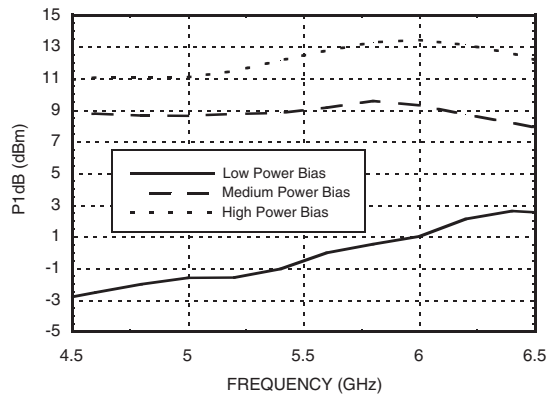

Reverse Isolation @ Three Bias Conditions

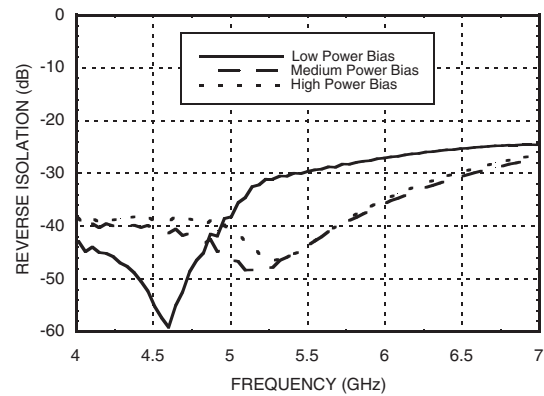



Adaptive Biasing

Optimizing P1dB Performance

The bias level may be changed to adjust the P1dB and return loss performance. The table below contains the HMC-320MS8G RF performance as a function of various VSET and RBIAS settings. It will be necessary for the VSET voltage source to provide 100uA of current to the amplifier. The Idd and Vdd quiescent performance will not change as a function of changing the VSET voltage.

RF Performance at 5.8 GHz (Vdd = +3V)

VSET (VDC)	RBIAS Resistor Between Pin 3 and GND (Ohms)	Idd (mA)	Output P1dB (dBm)	Output Return Loss (dB)
0	174	7	1.0	16.0
3	22	25	9.0	12.0
3	7	40	13.0	15.0
3	GND (No Resistor)	60	14.0	15.0

Applying the adaptive biasing

A dynamically controlled bias can be implemented with this design. A typical application will include sensing an RF signal level and then adjusting the VSET. The bias adjustment can be accomplished by either analog or digital means, after the RF signal has been detected and translated to a DC voltage using external power detection circuitry.

Schematic

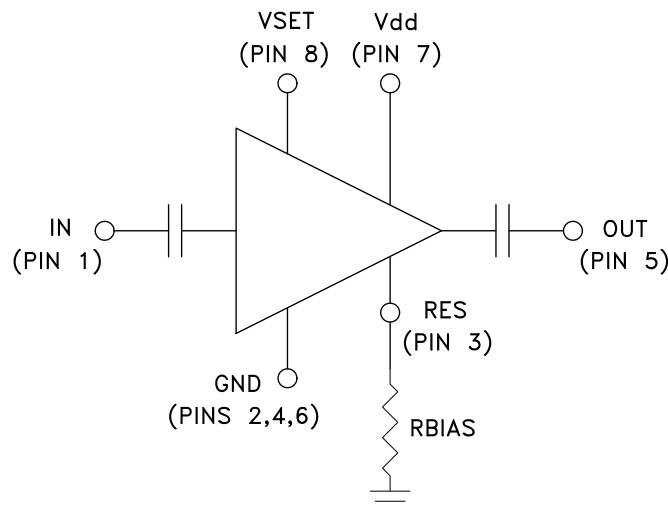



GaAs MMIC LOW NOISE AMPLIFIER, 5 - 6 GHz

Absolute Maximum Ratings

Drain Bias Voltage (Vdd)	+7.0 Vdc
Control Voltage Range (VSET)	0 to Vdd
RF Input Power (RFIN)(Vdd = +3.0 Vdc)	+5 dBm
Channel Temperature	150 °C
Continuous Pdiss (T = 85 °C) (derate 2.98 mW/°C above 85 °C)	0.194 W
Thermal Resistance (channel to ground paddle)	336 °C/W
Storage Temperature	-65 to +150 °C
Operating Temperature	-40 to +85 °C
ESD Sensitivity (HBM)	Class 1A

Truth Table

VSET	Operating Current Idd	Operating State	Resistor Rbias
0V	7 mA	Low Power	174 Ohm
3V	25 mA	Medium Power	22 Ohm
3V	40 mA	High Power	7 Ohm

Set external bias resistor (RBIAS) to achieve desired operating current, $0 < R_{BIAS} < 200$ Ohm.



**ELECTROSTATIC SENSITIVE DEVICE
OBSERVE HANDLING PRECAUTIONS**

Outline Drawing

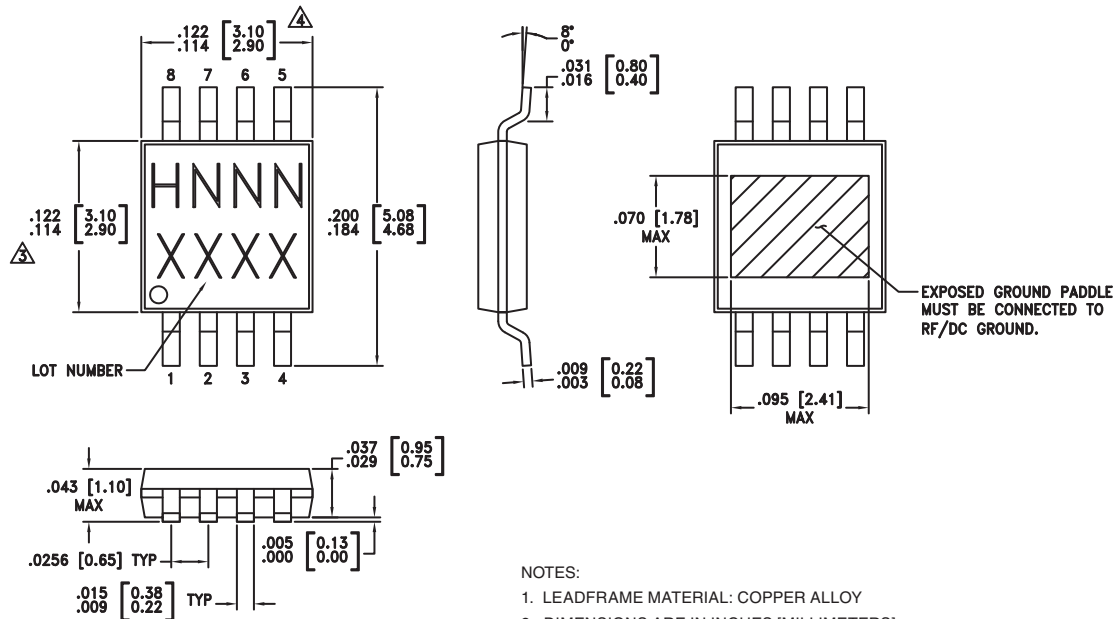

EXPOSED GROUND PADDLE
MUST BE CONNECTED TO
RF/DC GROUND.

NOTES:

- LEADFRAME MATERIAL: COPPER ALLOY
- DIMENSIONS ARE IN INCHES [MILLIMETERS]
- Δ DIMENSION DOES NOT INCLUDE MOLDFLASH OF 0.15mm PER SIDE.
- ∇ DIMENSION DOES NOT INCLUDE MOLDFLASH OF 0.25mm PER SIDE.
- ALL GROUND LEADS AND GROUND PADDLE MUST BE SOLDERED TO PCB RF GROUND.

Package Information

Part Number	Package Body Material	Lead Finish	MSL Rating	Package Marking ^[3]
HMC320MS8G	Low Stress Injection Molded Plastic	Sn/Pb Solder	MSL1 ^[1]	H320 XXXX
HMC320MS8GE	RoHS-compliant Low Stress Injection Molded Plastic	100% matte Sn	MSL1 ^[2]	<u>H320</u> XXXX

[1] Max peak reflow temperature of 235 °C

[2] Max peak reflow temperature of 260 °C

[3] 4-Digit lot number XXXX



Evaluation PCB

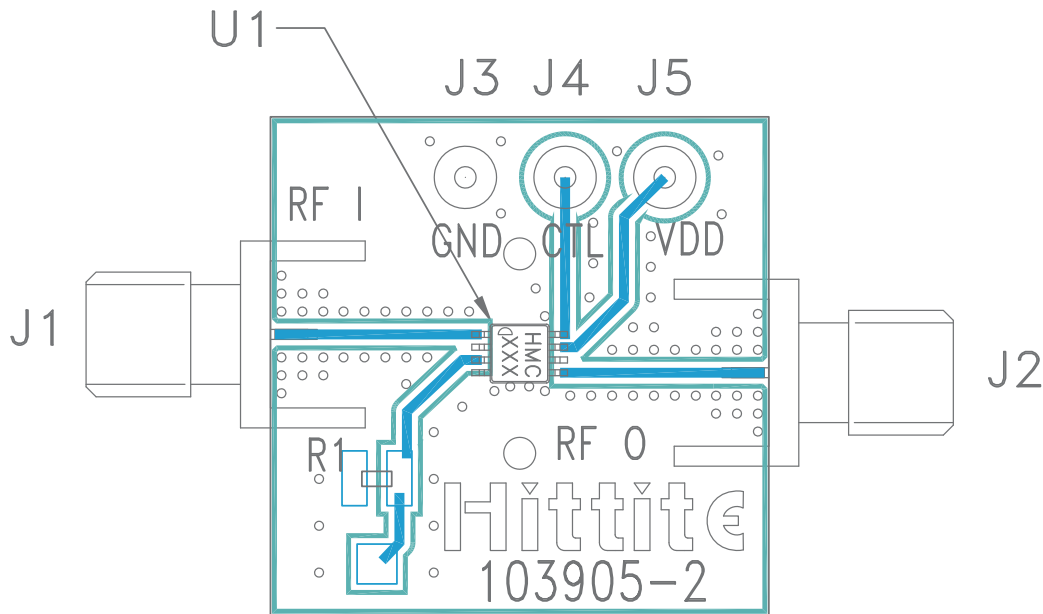

List of Materials for Evaluation PCB 103907 [1]

Item	Description
J1, J2	PCB Mount SMA Connector
J3, J4, J5	DC Pins
R1	22 Ohm Resistor, 0603 Pkg.
U1	HMC320MS8G / HMC320MS8GE Amplifier
PCB [2]	103905 Evaluation PCB

[1] Reference this number when ordering complete evaluation PCB

[2] Circuit Board Material: Rogers 4350

The circuit board used in the final application should use RF circuit design techniques. Signal lines should have 50 ohm impedance while the package ground leads and exposed paddle should be connected directly to the ground plane similar to that shown. A sufficient number of via holes should be used to connect the top and bottom ground planes. The evaluation circuit board shown is available from Hittite upon request.