

THIS DRAWING IS UNPUBLISHED. RELEASED FOR PUBLICATION 20
 © COPYRIGHT 20 BY - ALL RIGHTS RESERVED.

REVISIONS

P	LTR	DESCRIPTION	DATE	DWN	APVD
A		INITIAL	05JAN2015	GY	CW
A1		ECR-15-004309	24MAR2015	GY	CW
B		ECR-15-013759	26SEP2015	DW	CW
B1		ECR-16-011988	27AUG2016	YC	CW

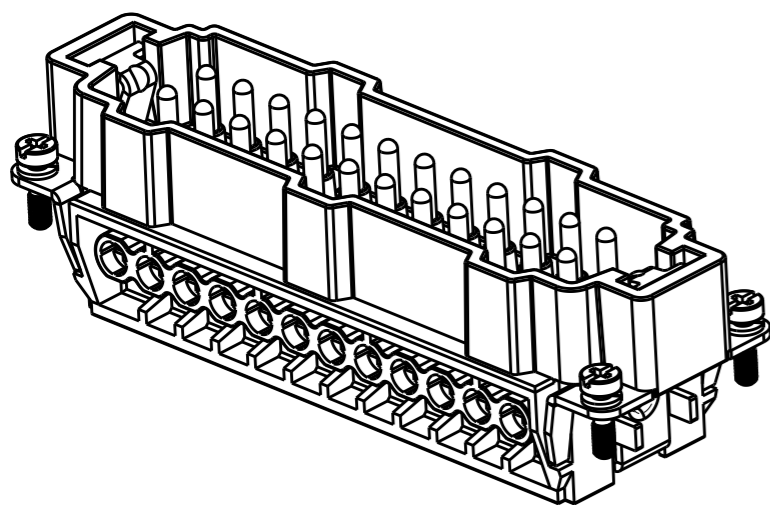

TYPE 1, T2040242101-000, WITH LOGO
 类型 1, T2040242101-000, 带LOGO

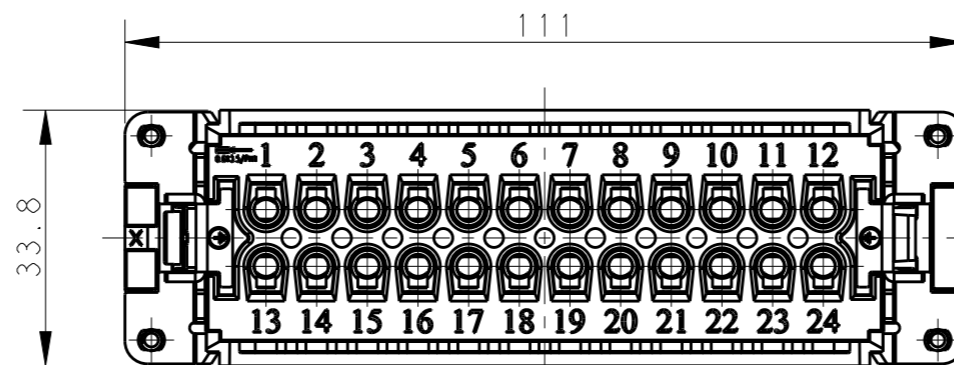

24X M3 SCREW, RECOMMENDED
 TIGHTENING TORQUE 0.5Nm
 24X M3螺丝, 推荐锁紧力矩0.5Nm

NOTES:

1. TECHNICAL CHARACTERISTICS:
 INSULATION MATERIAL: PC
 RATED VOLTAGE: 500V
 RATED CURRENT: 16A
 INSULATION RESISTANCE: $\geq 400M\Omega$
 RATED IMPULSE VOLTAGE: 6KV
 POLLUTION DEGREE: 3
 FLAMMABILITY: UL94V-0
 MATING CYCLES: 500 CYCLES
 WIRE RANGE: $0.5mm^2 \sim 2.5mm^2$ (AWG20-AWG14)
 CONTACT TYPE: SCREW CLAMP (M3)

注释:

1. 技术参数:
 绝缘材料: PC
 额定电压: 500V
 额定电流: 16A
 绝缘电阻: $\geq 400M\Omega$
 脉冲电压: 6KV
 污染等级: 3
 阻燃等级: UL94V-0
 插拔次数: 500 次
 接线范围: $0.5mm^2 \sim 2.5mm^2$ (AWG20-AWG14)
 接线类型: 螺丝压接 (M3)

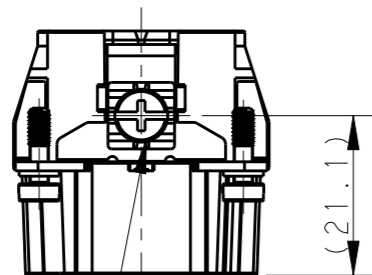

M4 SCREW, RECOMMENDED
 TIGHTENING TORQUE 1.2Nm
 M4螺丝, 推荐锁紧力矩1.2Nm

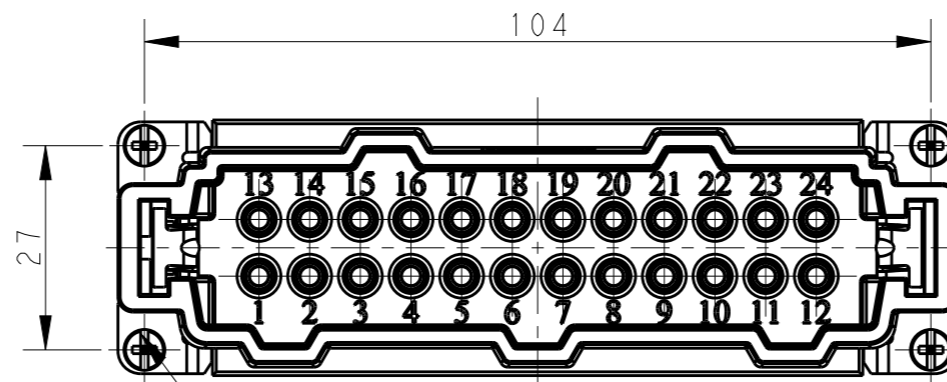
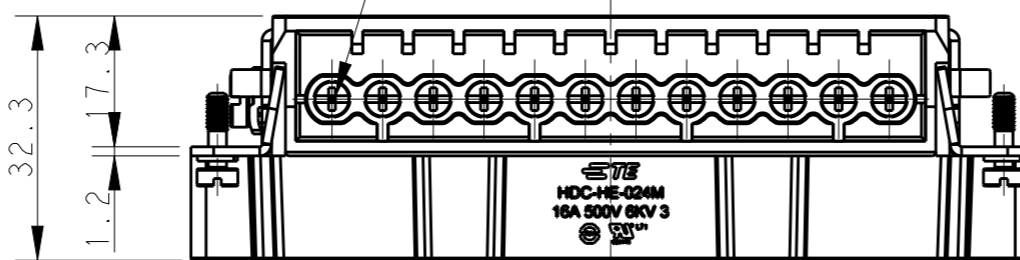

4X M3 SCREW, RECOMMENDED
 TIGHTENING TORQUE 0.5Nm
 4X M3螺丝, 推荐锁紧力矩0.5Nm

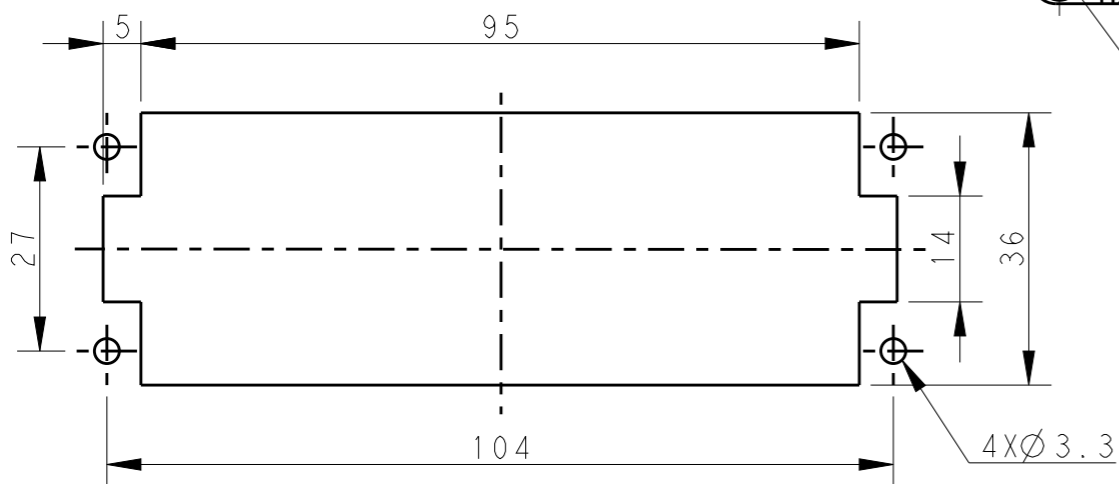

PANEL CUT FOR INSERTS FOR USE
 WITHOUT HOODS/ HOUSINGS
 不使用防护外壳时芯件的安装开孔图

THIS DRAWING IS A CONTROLLED DOCUMENT.		DWN	GINO YAO	12AUG2014	 TE Connectivity	NAME		HE-024-M	
DIMENSIONS:		CHK	CHRIS WANG	12AUG2014		PRODUCT SPEC		108-137044	
mm		APVD	XIANG XU	12AUG2014		APPLICATION SPEC		114-137044	
TOLERANCES UNLESS OTHERWISE SPECIFIED:		MATERIAL		FINISH		WEIGHT	SIZE	CAGE CODE	DRAWING NO
0 PLC	±-	-		-	-	A3	00779	©-T2040242101000	-
1 PLC	±-	-		-	-	SCALE		1:1	SHEET
2 PLC	±-	-		-	-	1 OF		2	REV
3 PLC	±-	-		-	-	CUSTOMER DRAWING		B1	
4 PLC	±-	-		-	-	SCALE		1:1	SHEET
ANGLES	±-	-		-	-	1 OF		2	REV
		-		-	-	CUSTOMER DRAWING		B1	

4

3

2

1

THIS DRAWING IS UNPUBLISHED.

RELEASED FOR PUBLICATION

20

© COPYRIGHT 20 BY -

ALL RIGHTS RESERVED.

REVISIONS

P	LTR	DESCRIPTION	DATE	DWN	APVD
		SEE SHEET 1			

NOTE:
ALL SPEC REFER TO TYPE 1

注释:
所有产品规范参照 TYPE 1

TYPE 2, T2040242101-001, WITHOUT LOGO
类型 2, T2040242101-001, 不带LOGO

T2040242101-000	HE-024-M	HE-024 MALE INSERT HE-024 公插	TYPE 1
T2040242101-001	HE-024-M	HE-024 MALE INSERT, WITHOUT LOGO HE-024 公插, 无LOGO	TYPE 2
PART NUMBER 料号	PART DESCRIPTION 描述		TYPE 类型

THIS DRAWING IS A CONTROLLED DOCUMENT.

DIMENSIONS:	TOLERANCES UNLESS OTHERWISE SPECIFIED:
mm	
	0 PLC ±-
	1 PLC ±-
	2 PLC ±-
	3 PLC ±-
	4 PLC ±-
	ANGLES ±-
MATERIAL	FINISH
-	-
-	-

DWN	12AUG2014
GINO YAO	
CHK	12AUG2014
CHRIS WANG	
APVD	12AUG2014
XIANG XU	
PRODUCT SPEC	108-137044
APPLICATION SPEC	114-137044
WEIGHT	-
CUSTOMER DRAWING	

		NAME		RESTRICTED TO
		HE-024-M		
SIZE	CAGE CODE	DRAWING NO	RESTRICTED TO	
A3	00779	©-T2040242101000	-	
SCALE		SHEET	OF	REV
1:1		2	2	B1

1470-19 (3/13)