

High Power LED Series 3535 Ceramic Hot Binning

LH351B

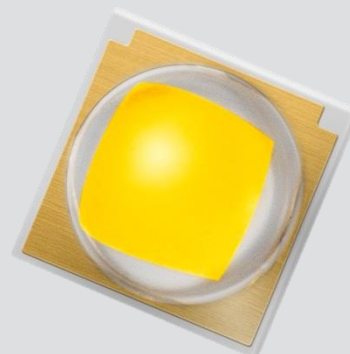

High efficacy and high quality color rendering makes the LH351B suitable use in a broad range of applications

Features & Benefits

- Operates at a maximum current of up to 1.5 A
- Uniform light distribution under any beam angle
- 80 CRI makes it well suited for most applications
- Hot binning @ 85 °C
- Completed 10,000 hours of LM-80 testing @ 1 A, 105 °C

Applications

- Indoor Lighting: Spotlight, Downlight
- Outdoor Lighting: Street Light, Tunnel Light, Security Light, Parking Lot Light
- Industrial Lighting: High Bay Light, Low Bay Light
- Consumer Lighting: Torch Light



Table of Contents

1.	Characteristics	-----	3
2.	Product Code Information	-----	7
3.	Typical Characteristics Graphs	-----	18
4.	Outline Drawing & Dimension	-----	20
5.	Reliability Test Items & Conditions	-----	21
6.	Soldering Conditions	-----	22
7.	Tape & Reel	-----	23
8.	Label Structure	-----	25
9.	Packing Structure	-----	26
10.	Precautions in Handling & Use	-----	28

1. Characteristics

a) Absolute Maximum Rating

Item	Symbol	Rating	Unit	Condition
Operating Temperature	T_{opr}	-40 ~ +105	°C	Note 1)*
Storage Temperature	T_{stg}	-40 ~ +120	°C	-
LED Junction Temperature	T_j	150	°C	-
Forward Current	I_F	1500	mA	-
Peak Pulse Forward Current	I_{FP}	2000	mA	Duty 1/10 pulse width 10ms
Assembly Process Temperature		260 <10	°C s	-
ESD (HBM)	-	±5	kV	-

Notes:

- 1) Refer to the derating curve, '3. Typical Characteristics Graph', for proper driving current that maintained below maximum junction temperature.

b) Electro-optical Characteristics

Item	Unit	Nominal CCT (K)	Condition		Value Typ.
			I _F (mA)	T _J (°C)	
Luminous Flux (Φ _v)	lm	3000 (80 CRI)	350	25	149
			350	85	136
			700	85	249
			1000	85	332
			1500	85	446
		5000 (70 CRI)	350	25	175
			350	85	160
			700	85	292
			1000	85	391
			1500	85	525
Forward Voltage (V _F)	V		350	25	2.86
			350	85	2.75
			700	85	2.89
			1000	85	2.99
			1500	85	3.12
Reverse Voltage (@ 5 mA)	V		350	25	14~19.5
Thermal Resistance (junction to solder point)	°C/W		350	25	4
Beam Angle	°		350	25	120

Notes:

- 1) Samsung maintains measurement tolerance of: luminous flux = ±7 %, forward voltage = ±0.1 V
- 2) Characteristics @ 25 °C are for reference only

c) Luminous Flux Characteristics (T_j = 85 °C)

Nominal CCT (K)	CRI (R _a) Min. ¹⁾	Sorting @ 350 mA (lm)		Calculated Minimum Flux ²⁾ (lm)			
		Flux Rank	Flux Min. ¹⁾	@ 700 mA	@ 1000 mA	@ 1500 mA	
2700	80	H3 (J3)	110 (121)	199 (218)	262 (288)	354 (389)	
		J3 (K3)	120 (132)	217 (238)	286 (314)	386 (424)	
		K3 (M3)	130 (143)	235 (258)	310 (340)	418 (460)	
	90	F3 (G3)	90 (99)	163 (179)	214 (236)	289 (318)	
		70	K3 (M3)	130 (143)	235 (258)	310 (340)	418 (460)
			M3 (N3)	140 (153)	252 (276)	335 (366)	457 (499)
N3 (P3)	150 (164)		270 (295)	359 (392)	489 (534)		
3000	80	H3 (J3)	110 (121)	199 (218)	262 (288)	354 (389)	
		J3 (K3)	120 (132)	217 (238)	286 (314)	386 (424)	
		K3 (M3)	130 (142)	234 (256)	311 (340)	424 (463)	
	90	F3 (G3)	90 (99)	163 (179)	214 (236)	289 (318)	
		70	K3 (M3)	130 (142)	234 (256)	311 (340)	424 (463)
			M3 (N3)	140 (153)	252 (276)	335 (366)	457 (499)
N3 (P3)	150 (164)		270 (295)	359 (392)	489 (534)		
3500	80	J3 (K3)	120 (132)	217 (238)	286 (314)	386 (424)	
		K3 (M3)	130 (142)	234 (256)	311 (340)	424 (463)	
		G3 (H3)	100 (110)	181 (199)	238 (262)	322 (353)	
	90	H3 (J3)	110 (121)	199 (218)	262 (288)	354 (389)	
		70	M3 (N3)	140 (153)	252 (276)	335 (366)	457 (499)
			N3 (P3)	150 (164)	270 (295)	359 (392)	489 (534)
4000	P3 (Q3)		160 (174)	288 (312)	382 (415)	518 (562)	
	80	J3 (K3)	120 (132)	217 (238)	286 (314)	386 (424)	
		K3 (M3)	130 (143)	235 (258)	310 (340)	418 (460)	
M3 (N3)		140 (153)	252 (276)	335 (366)	457 (499)		

(value in bracket): Minimum luminous flux @ 25 °C, for reference only

Notes:

- 1) Samsung maintains measurement tolerance of: luminous flux = ±7 %, CRI = ±3
- 2) Calculated minimum flux values are for reference only

c) Luminous Flux Characteristics (T_j = 85 °C)

Nominal CCT (K)	CRI (R _a) Min. ¹⁾	Sorting @ 350 mA (lm)		Calculated Minimum Flux ²⁾ (lm)		
		Flux Rank	Flux Min. ¹⁾	@ 700 mA	@ 1000 mA	@ 1500 mA
5000	70	M3 (N3)	140 (153)	252 (276)	335 (366)	457 (499)
		N3 (P3)	150 (164)	270 (295)	359 (392)	489 (534)
		P3 (Q3)	160 (174)	288 (312)	382 (415)	518 (562)
	80	K3 (M3)	130 (142)	234 (256)	311 (340)	424 (463)
		M3 (N3)	140 (153)	252 (276)	335 (366)	457 (499)
		N3 (P3)	150 (164)	270 (295)	359 (392)	489 (534)
5700	70	M3 (N3)	140 (153)	252 (276)	335 (366)	457 (499)
		N3 (P3)	150 (164)	270 (295)	359 (392)	489 (534)
		P3 (Q3)	160 (174)	288 (312)	382 (415)	518 (562)
	75	M3 (N3)	140 (153)	252 (276)	335 (366)	457 (499)
		N3 (P3)	150 (164)	270 (295)	359 (392)	489 (534)
		K3 (M3)	130 (142)	234 (256)	311 (340)	424 (463)
6000K	80	M3 (N3)	140 (153)	252 (276)	335 (366)	457 (499)
		N3 (P3)	150 (164)	270 (295)	359 (392)	489 (534)
		P3 (Q3)	160 (174)	288 (312)	382 (415)	518 (562)
	70	K3 (M3)	130 (142)	234 (256)	311 (340)	424 (463)
		M3 (N3)	140 (153)	252 (276)	335 (366)	457 (499)
		N3 (P3)	150 (164)	270 (295)	359 (392)	489 (534)
6500	80	M3 (N3)	140 (153)	252 (276)	335 (366)	457 (499)
		N3 (P3)	150 (164)	270 (295)	359 (392)	489 (534)
		P3 (Q3)	160 (174)	288 (312)	382 (415)	518 (562)
	70	K3 (M3)	130 (142)	234 (256)	311 (340)	424 (463)
		M3 (N3)	140 (153)	252 (276)	335 (366)	457 (499)
		N3 (P3)	150 (164)	270 (295)	359 (392)	489 (534)

(value in bracket): Minimum luminous flux @ 25 °C, for reference only

Notes:

- 1) Samsung maintains measurement tolerance of: luminous flux = ±7 %, CRI = ±3
- 2) Calculated minimum flux values are for reference only

2. Product Code Information

1	2	3	4	5	6	7	8	9	10	11	12	13	14	15	16	17	18
S	P	H	W	H	2	L	3	D	3	0	E	D	4	V	0	K	3

Digit	PKG Information	Code	Specification
1 2 3	Samsung Package High Power	SPH	
4 5	Color	WH	White
6	Product Version	2	
7 8	Product	L3	LH351 Series
9	Lens Type	D	Dome lens
10	Internal Code	3	
11	Not Defined	0	Default
12	CRI & Sorting Temperature	C D E F G	Min. 70 Min. 75 Min. 80 85°C Min. 50 Min. 90
13 14	Forward Voltage (V)	D 4	2.6~3.0 Bin Code: D2 2.6~2.8 F2 2.8~3.0
15 16	CCT (K)	W ★ V ★ U ★ T ★ R T Q T P Q P T	2700 W1, W2, W3, W4, W5, W6, W7, W8, W9, WA, WB, WC, WD, WE, WF, WG, WM 3000 V1, V2, V3, V4, V5, V6, V7, V8, V9, VA, VB, VC, VD, VE, VF, VG, VM 3500 U1, U2, U3, U4, U5, U6, U7, U8, U9, UA, UB, UC, UD, UE, UF, UG, UM 4000 Bin Code: 5000 T1, T2, T3, T4, T5, T6, T7, T8, T9, TA, TB, TC, TD, TE, TF, TG, TM 5700 R1, R2, R3, R4 6000 Q1, Q2, Q3, Q4 6500 P1, P2, P3, P4 ★ : "0" (Whole bin), "P" (Quarter bin), or "M" (MacAdam 3-step ellipse bin)
17 18	Luminous Flux (lm)	F 3 G 3 H 3 J 3 K 3 M 3 N 3 P 3	90~120 F1 90~100 100~130 G1 100~110 110~140 H1 110~120 120~150 J1 120~130 130~160 K1 130~140 140~170 M1 140~150 150~180 N1 150~160 160~190 P1 160~170 Q1 170~180 R1 180~190 Digit 17: Min. spec. Digit 18: The number of higher bin(s) from min. spec. e.g.: K1 = 130~140 lm, K3 = 130~160 lm

a) Luminous Flux Bins ($I_F = 350 \text{ mA}$, $T_j = 85 \text{ }^\circ\text{C}$)

Nominal CCT (K)	CRI (R _a) Min.	Product Code	Flux Rank	Flux Bin	Flux Range (Φ_v , lm)
2700	80	SPHWH2L3D30ED4W ☆H3	H3	H1	110 ~ 120
				J1	120 ~ 130
				K1	130 ~ 140
		SPHWH2L3D30ED4W ☆J3	J3	J1	120 ~ 130
				K1	130 ~ 140
				M1	140 ~ 150
	SPHWH2L3D30ED4W ☆K3	K3	K1	130 ~ 140	
			M1	140 ~ 150	
			N1	150 ~ 160	
	90	SPHWH2L3D30GD4W ☆F3	F3	F1	90 ~ 100
				G1	100 ~ 110
				H1	110 ~ 120
SPHWH2L3D30CD4V ☆K3		K3	K1	130 ~ 140	
			M1	140 ~ 150	
			N1	150 ~ 160	
3000	70	SPHWH2L3D30CD4V ☆M3	M3	M1	140 ~ 150
				N1	150 ~ 160
				P1	160 ~ 170
		SPHWH2L3D30CD4V ☆N3	N3	N1	150 ~ 160
				P1	160 ~ 170
				Q1	170 ~ 180
	80	SPHWH2L3D30ED4V ☆H3	H3	H1	110 ~ 120
				J1	120 ~ 130
				K1	130 ~ 140
		SPHWH2L3D30ED4V ☆J3	J3	J1	120 ~ 130
				K1	130 ~ 140
				M1	140 ~ 150
SPHWH2L3D30ED4V ☆K3	K3	K1	130 ~ 140		
		M1	140 ~ 150		
		N1	150 ~ 160		
90	SPHWH2L3D30GD4V ☆F3	F3	F1	90 ~ 100	
			G1	100 ~ 110	
			H1	110 ~ 120	
	SPHWH2L3D30CD4U ☆K3	K3	K1	130 ~ 140	
			M1	140 ~ 150	
			N1	150 ~ 160	
3500	70	SPHWH2L3D30CD4U ☆M3	M3	M1	140 ~ 150
				N1	150 ~ 160
				P1	160 ~ 170
		SPHWH2L3D30ED4U ☆J3	J3	J1	120 ~ 130
				K1	130 ~ 140
				M1	140 ~ 150
	SPHWH2L3D30ED4U ☆K3	K3	K1	130 ~ 140	
			M1	140 ~ 150	
			N1	150 ~ 160	
	90	SPHWH2L3D30GD4U ☆G3	G3	G1	100 ~ 110
				H1	110 ~ 120
				J1	120 ~ 130
SPHWH2L3D30GD4U ☆H3		H3	H1	110 ~ 120	
			J1	120 ~ 130	
			K1	130 ~ 140	

"☆" can be "0" (Whole bin), "P" (Quarter bin), or "M" (MacAdam 3-step ellipse bin) of the color binning

a) Luminous Flux Bins ($I_F = 350 \text{ mA}$, $T_j = 85 \text{ }^\circ\text{C}$)

Nominal CCT (K)	CRI (R _a) Min.	Product Code	Flux Rank	Flux Bin	Flux Range (Φ_v , lm)
4000	70	SPHWH2L3D30CD4T ☆M3	M3	M1	140 ~ 150
				N1	150 ~ 160
				P1	160 ~ 170
		SPHWH2L3D30CD4T ☆N3	N3	N1	150 ~ 160
				P1	160 ~ 170
				Q1	170 ~ 180
	SPHWH2L3D30CD4T ☆P3	P3	P1	160 ~ 170	
			Q1	170 ~ 180	
			R1	180 ~ 190	
	80	SPHWH2L3D30ED4T ☆J3	J3	J1	120 ~ 130
				K1	130 ~ 140
				M1	140 ~ 150
SPHWH2L3D30ED4T ☆K3		K3	K1	130 ~ 140	
			M1	140 ~ 150	
			N1	150 ~ 160	
5000	70	SPHWH2L3D30ED4T ☆M3	M3	M1	140 ~ 150
				N1	150 ~ 160
				P1	160 ~ 170
		SPHWH2L3D30CD4RTM3	M3	N1	150 ~ 160
				P1	160 ~ 170
				N1	150 ~ 160
	SPHWH2L3D30CD4RTN3	N3	P1	160 ~ 170	
			Q1	170 ~ 180	
			P1	160 ~ 170	
	80	SPHWH2L3D30CD4RTP3	P3	Q1	170 ~ 180
				R1	180 ~ 190
				K1	130 ~ 140
SPHWH2L3D30ED4RTK3		K3	M1	140 ~ 150	
			N1	150 ~ 160	
			M1	140 ~ 150	
SPHWH2L3D30ED4RTM3	M3	N1	150 ~ 160		
		P1	160 ~ 170		

"☆" can be "0" (Whole bin), "P" (Quarter bin), or "M" (MacAdam 3-step ellipse bin) of the color binning

a) Luminous Flux Bins ($I_F = 350 \text{ mA}$, $T_j = 85 \text{ }^\circ\text{C}$)

Nominal CCT (K)	CRI (R _a) Min.	Product Code	Flux Rank	Flux Bin	Flux Range (Φ_v , lm)
5700	70	SPHWH2L3D30CD4QTM3	M3	M1	140 ~ 150
				N1	150 ~ 160
				P1	160 ~ 170
		SPHWH2L3D30CD4QTN3	N3	N1	150 ~ 160
				P1	160 ~ 170
				Q1	170 ~ 180
	SPHWH2L3D30CD4QTP3	P3	P1	160 ~ 170	
			Q1	170 ~ 180	
			R1	180 ~ 190	
	75	SPHWH2L3D30DD4QTM3	M3	M1	140 ~ 150
				N1	150 ~ 160
				P1	160 ~ 170
SPHWH2L3D30DD4QTN3		N3	N1	150 ~ 160	
			P1	160 ~ 170	
			Q1	170 ~ 180	
80	SPHWH2L3D30ED4QTK3	K3	K1	130 ~ 140	
			M1	140 ~ 150	
			N1	150 ~ 160	
	SPHWH2L3D30ED4QTM3	M3	M1	140 ~ 150	
			N1	150 ~ 160	
			P1	160 ~ 170	
6000	80	SPHWH2L3D30ED4PQK3	K3	K1	130 ~ 140
				M1	140 ~ 150
				N1	150 ~ 160
		SPHWH2L3D30ED4PQM3	M3	M1	140 ~ 150
				N1	150 ~ 160
				P1	160 ~ 170
6500	70	SPHWH2L3D30CD4PTM3	M3	M1	140 ~ 150
				N1	150 ~ 160
				P1	160 ~ 170
		SPHWH2L3D30CD4PTN3	N3	N1	150 ~ 160
				P1	160 ~ 170
				Q1	170 ~ 180
	80	SPHWH2L3D30ED4PTK3	K3	K1	130 ~ 140
				M1	140 ~ 150
				N1	150 ~ 160
		SPHWH2L3D30ED4PTM3	M3	M1	140 ~ 150
				N1	150 ~ 160
				P1	160 ~ 170

b) Color Bins ($I_f = 350 \text{ mA}$, $T_j = 85 \text{ }^\circ\text{C}$)

Nominal CCT (K)	CRI (R _s) Min.	Product Code	Color Rank	Chromaticity Bins	
2700	80	SPHWH2L3D30ED4W0H3	W0 (Whole bin)	W1, W2, W3, W4, W5, W6, W7, W8, W9, WA, WB, WC, WD, WE, WF, WG	
		SPHWH2L3D30ED4W0J3			
		SPHWH2L3D30ED4W0K3			
		SPHWH2L3D30ED4WPH3	WP (Quarter bin)		
		SPHWH2L3D30ED4WPJ3			
		SPHWH2L3D30ED4WPK3			
	SPHWH2L3D30ED4WMH3	WM (MacAdam 3-step)	WM		
	SPHWH2L3D30ED4WMJ3				
	SPHWH2L3D30ED4WMK3				
	90	SPHWH2L3D30GD4W0F3		W0 (Whole bin)	W1, W2, W3, W4, W5, W6, W7, W8, W9, WA, WB, WC, WD, WE, WF, WG
		SPHWH2L3D30GD4WPF3			
		SPHWH2L3D30GD4WMP3			
SPHWH2L3D30GD4WVF3		VP (Quarter bin)			
SPHWH2L3D30GD4VPH3					
SPHWH2L3D30GD4VPM3					
SPHWH2L3D30GD4VMH3	VM (MacAdam 3-step)	VM			
SPHWH2L3D30GD4VMJ3					
SPHWH2L3D30GD4VMK3					
3000	70		SPHWH2L3D30CD4V0K3	V0 (Whole bin)	V1, V2, V3, V4, V5, V6, V7, V8, V9, VA, VB, VC, VD, VE, VF, VG
			SPHWH2L3D30CD4V0M3		
			SPHWH2L3D30CD4V0N3		
		SPHWH2L3D30CD4VPH3	VP (Quarter bin)		
		SPHWH2L3D30CD4VPM3			
		SPHWH2L3D30CD4VPN3			
	SPHWH2L3D30CD4VMH3	VM (MacAdam 3-step)	VM		
	SPHWH2L3D30CD4VMJ3				
	SPHWH2L3D30CD4VMK3				
	80	SPHWH2L3D30ED4V0H3		V0 (Whole bin)	V1, V2, V3, V4, V5, V6, V7, V8, V9, VA, VB, VC, VD, VE, VF, VG
		SPHWH2L3D30ED4V0J3			
		SPHWH2L3D30ED4V0K3			
SPHWH2L3D30ED4VPH3		VP (Quarter bin)			
SPHWH2L3D30ED4VPJ3					
SPHWH2L3D30ED4VPK3					
SPHWH2L3D30ED4VMH3	VM (MacAdam 3-step)	VM			
SPHWH2L3D30ED4VMJ3					
SPHWH2L3D30ED4VMK3					
90	SPHWH2L3D30GD4V0F3		V0 (Whole bin)	V1, V2, V3, V4, V5, V6, V7, V8, V9, VA, VB, VC, VD, VE, VF, VG	
	SPHWH2L3D30GD4VPF3				
	SPHWH2L3D30GD4VMP3				
	SPHWH2L3D30GD4VVF3	VP (Quarter bin)			
	SPHWH2L3D30GD4VPH3				
	SPHWH2L3D30GD4VPM3				
SPHWH2L3D30GD4VMH3	VM (MacAdam 3-step)	VM			
SPHWH2L3D30GD4VMJ3					
SPHWH2L3D30GD4VMK3					
3500	70		SPHWH2L3D30CD4U0K3	U0 (Whole bin)	U1, U2, U3, U4, U5, U6, U7, U8, U9, UA, UB, UC, UD, UE, UF, UG
			SPHWH2L3D30CD4U0M3		
			SPHWH2L3D30CD4U0N3		
		SPHWH2L3D30CD4UPH3	UP (Quarter bin)		
		SPHWH2L3D30CD4UPM3			
		SPHWH2L3D30CD4UPN3			
	SPHWH2L3D30CD4UMH3	UM (MacAdam 3-step)	UM		
	SPHWH2L3D30CD4UMJ3				
	SPHWH2L3D30CD4UMK3				
	80	SPHWH2L3D30ED4U0H3		U0 (Whole bin)	U1, U2, U3, U4, U5, U6, U7, U8, U9, UA, UB, UC, UD, UE, UF, UG
		SPHWH2L3D30ED4U0J3			
		SPHWH2L3D30ED4U0K3			
SPHWH2L3D30ED4UPH3		UP (Quarter bin)			
SPHWH2L3D30ED4UPM3					
SPHWH2L3D30ED4UPN3					
SPHWH2L3D30ED4UMH3	UM (MacAdam 3-step)	UM			
SPHWH2L3D30ED4UMJ3					
SPHWH2L3D30ED4UMK3					
90	SPHWH2L3D30GD4U0G3		U0 (Whole bin)	U1, U2, U3, U4, U5, U6, U7, U8, U9, UA, UB, UC, UD, UE, UF, UG	
	SPHWH2L3D30GD4U0H3				
	SPHWH2L3D30GD4U0J3				
	SPHWH2L3D30GD4UPG3	UP (Quarter bin)			
	SPHWH2L3D30GD4UPH3				
	SPHWH2L3D30GD4UPM3				
SPHWH2L3D30GD4UMG3	UM (MacAdam 3-step)	UM			
SPHWH2L3D30GD4UMH3					
SPHWH2L3D30GD4UMJ3					

b) Color Bins ($I_f = 350 \text{ mA}$, $T_j = 85 \text{ }^\circ\text{C}$)

Nominal CCT (K)	CRI (R _a) Min.	Product Code	Color Rank	Chromaticity Bins	
4000	70	SPHWH2L3D30CD4T0M3	T0 (Whole bin)	T1, T2, T3, T4, T5, T6, T7, T8, T9, TA, TB, TC, TD, TE, TF, TG	
		SPHWH2L3D30CD4T0N3			
		SPHWH2L3D30CD4T0P3			
		SPHWH2L3D30CD4TPM3	TP (Quarter bin)		
		SPHWH2L3D30CD4TPN3			
		SPHWH2L3D30CD4TPP3			
		SPHWH2L3D30CD4TMM3	TM (MacAdam 3-step)		
	SPHWH2L3D30CD4TMN3				
	SPHWH2L3D30CD4TMP3				
	80	80	SPHWH2L3D30ED4T0J3	T0 (Whole bin)	T1, T2, T3, T4, T5, T6, T7, T8, T9, TA, TB, TC, TD, TE, TF, TG
			SPHWH2L3D30ED4T0K3		
			SPHWH2L3D30ED4T0M3		
			SPHWH2L3D30ED4TPJ3	TP (Quarter bin)	
			SPHWH2L3D30ED4TPK3		
SPHWH2L3D30ED4TPM3					
SPHWH2L3D30ED4TMJ3			TM (MacAdam 3-step)		
SPHWH2L3D30ED4TMK3					
SPHWH2L3D30ED4TMM3					
5000	70	SPHWH2L3D30CD4RTM3	RT (Half bin)	R1, R2, R3, R4	
		SPHWH2L3D30CD4RTN3			
		SPHWH2L3D30CD4RTP3			
	80	SPHWH2L3D30ED4RTK3			
		SPHWH2L3D30ED4RTM3			
5700	70	SPHWH2L3D30CD4QTM3	QT (Half bin)	Q1, Q2, Q3, Q4	
		SPHWH2L3D30CD4QTN3			
		SPHWH2L3D30CD4QTP3			
	75	SPHWH2L3D30DD4QTM3			
		SPHWH2L3D30DD4QTN3			
		SPHWH2L3D30DD4QTP3			
80	SPHWH2L3D30ED4QTK3				
	SPHWH2L3D30ED4QTM3				
	6000	80	SPHWH2L3D30ED4PQK3	PQ (Half bin)	Q1, Q3, P2, P4
			SPHWH2L3D30ED4PQM3		
6500	70	SPHWH2L3D30CD4PTM3	PT (Half bin)	P1, P2, P3, P4	
		SPHWH2L3D30CD4PTN3			
	80	SPHWH2L3D30ED4PTK3			
		SPHWH2L3D30ED4PTM3			

c) Voltage Bins ($I_F = 350 \text{ mA}$, $T_j = 85 \text{ °C}$)

Nominal CCT (K)	CRI (R _a) Min.	Product Code	Voltage Rank	Voltage Bin	Voltage Range (V)
-	-	-	D4	D2	2.6 ~ 2.8
				F2	2.8 ~ 3.0

d) Chromaticity Region & Coordinates ($I_f = 350 \text{ mA}$, $T_j = 85 \text{ }^\circ\text{C}$)

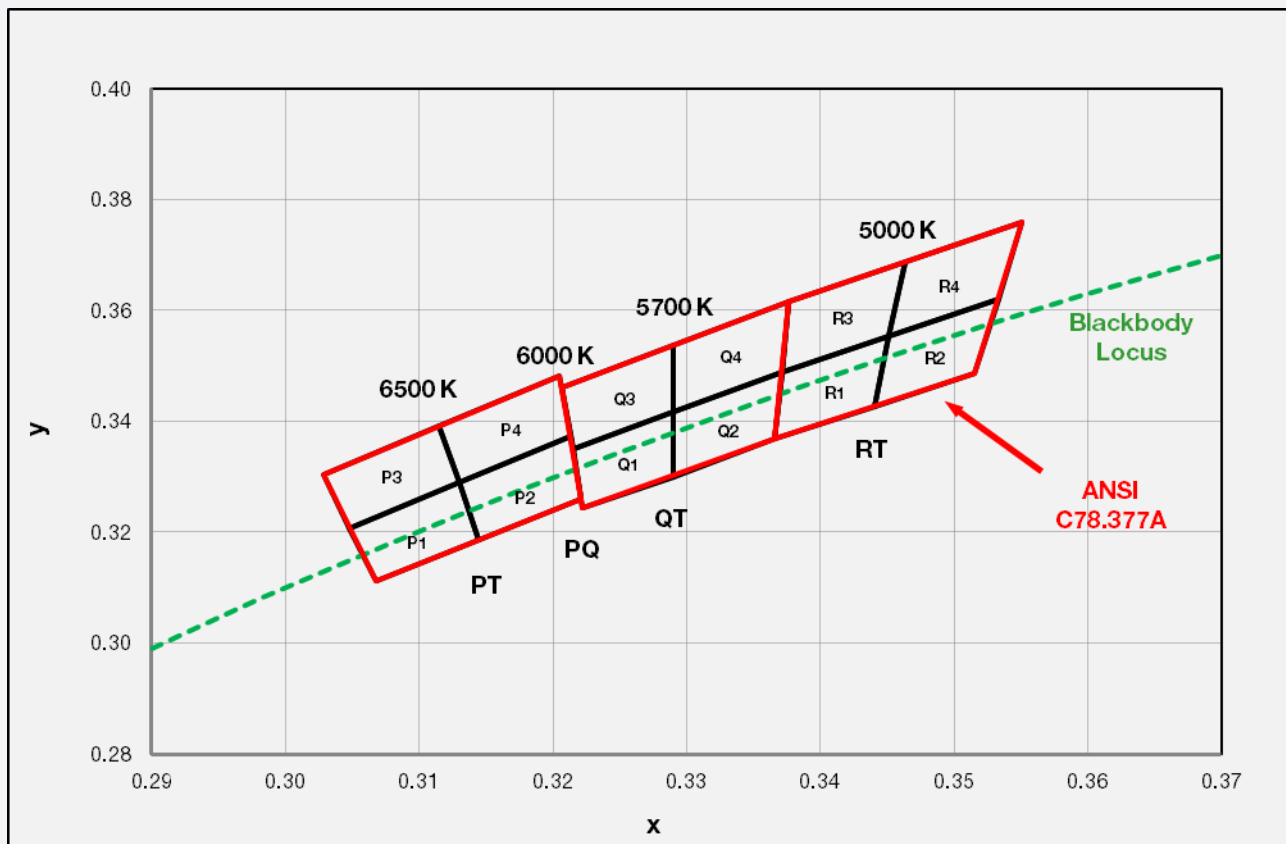
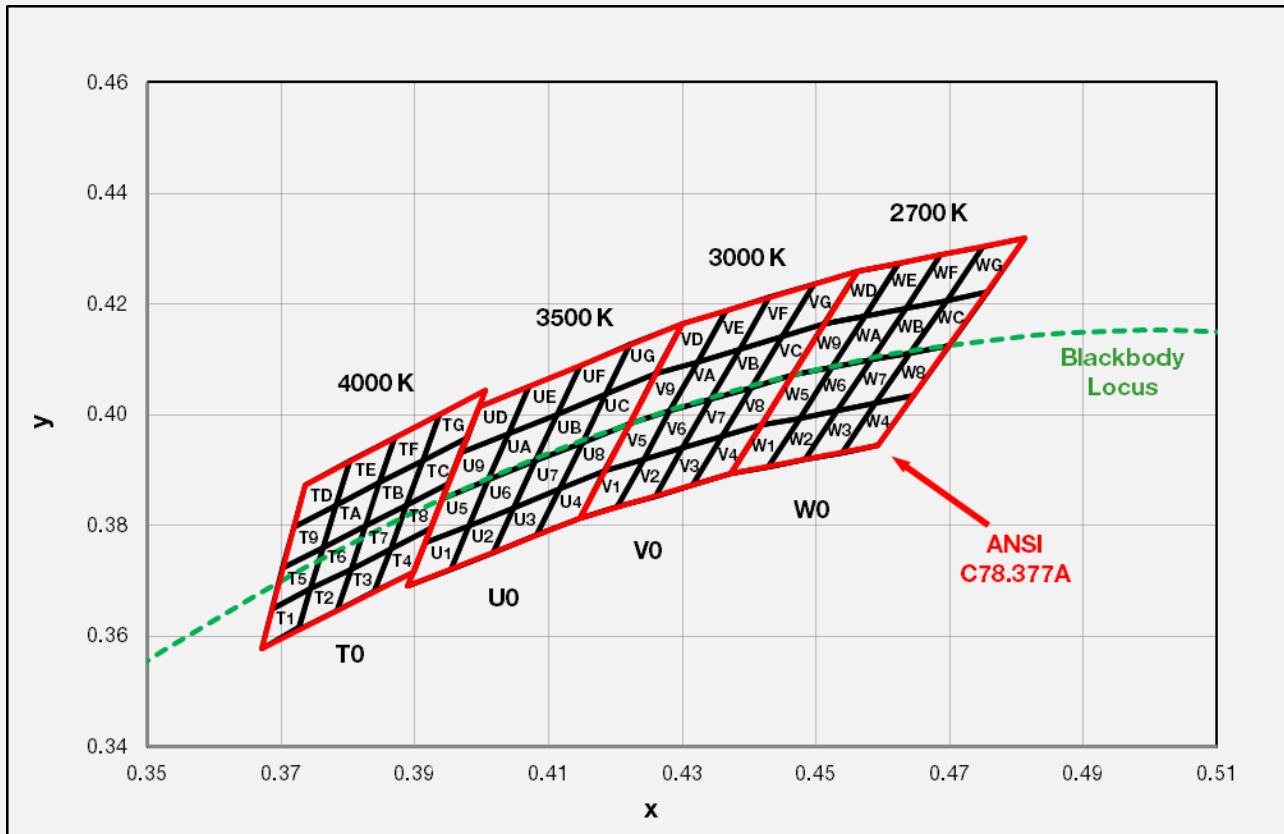

d) Chromaticity Region & Coordinates (I_F = 350 mA, T_j = 85 °C)

Region	CIE x	CIE y	Region	CIE x	CIE y
W rank (2700 K)					
W1	0.4373	0.3893	W9	0.4465	0.4071
	0.4418	0.3981		0.4513	0.4164
	0.4475	0.3994		0.4573	0.4178
	0.4428	0.3906		0.4523	0.4085
W2	0.4428	0.3906	WA	0.4523	0.4085
	0.4475	0.3994		0.4573	0.4178
	0.4532	0.4008		0.4634	0.4193
	0.4483	0.3919		0.4582	0.4099
W3	0.4483	0.3919	WB	0.4582	0.4099
	0.4532	0.4008		0.4634	0.4193
	0.4589	0.4021		0.4695	0.4207
	0.4538	0.3931		0.4641	0.4112
W4	0.4538	0.3931	WC	0.4641	0.4112
	0.4589	0.4021		0.4695	0.4207
	0.4646	0.4034		0.4756	0.4221
	0.4593	0.3944		0.4700	0.4126
W5	0.4418	0.3981	WD	0.4513	0.4164
	0.4465	0.4071		0.4562	0.4260
	0.4523	0.4085		0.4624	0.4274
	0.4475	0.3994		0.4573	0.4178
W6	0.4475	0.3994	WE	0.4573	0.4178
	0.4523	0.4085		0.4624	0.4274
	0.4582	0.4099		0.4687	0.4289
	0.4532	0.4008		0.4634	0.4193
W7	0.4532	0.4008	WF	0.4634	0.4193
	0.4582	0.4099		0.4687	0.4289
	0.4641	0.4112		0.4750	0.4304
	0.4589	0.4021		0.4695	0.4207
W8	0.4589	0.4021	WG	0.4695	0.4207
	0.4641	0.4112		0.4750	0.4304
	0.4700	0.4126		0.4813	0.4319
	0.4646	0.4034		0.4756	0.4221

Region	CIE x	CIE y	Region	CIE x	CIE y
V rank (3000 K)					
V1	0.4147	0.3814	V9	0.4221	0.3984
	0.4183	0.3898		0.4259	0.4073
	0.4242	0.3919		0.4322	0.4096
	0.4203	0.3833		0.4281	0.4006
V2	0.4203	0.3833	VA	0.4281	0.4006
	0.4242	0.3919		0.4322	0.4096
	0.4300	0.3939		0.4385	0.4119
	0.4259	0.3853		0.4342	0.4028
V3	0.4259	0.3853	VB	0.4342	0.4028
	0.4300	0.3939		0.4385	0.4119
	0.4359	0.3960		0.4449	0.4141
	0.4316	0.3873		0.4403	0.4049
V4	0.4316	0.3873	VC	0.4403	0.4049
	0.4359	0.3960		0.4449	0.4141
	0.4418	0.3981		0.4513	0.4164
	0.4373	0.3893		0.4465	0.4071
V5	0.4183	0.3898	VD	0.4259	0.4073
	0.4221	0.3984		0.4299	0.4165
	0.4281	0.4006		0.4364	0.4188
	0.4242	0.3919		0.4322	0.4096
V6	0.4242	0.3919	VE	0.4322	0.4096
	0.4281	0.4006		0.4364	0.4188
	0.4342	0.4028		0.4430	0.4212
	0.4300	0.3939		0.4385	0.4119
V7	0.4300	0.3939	VF	0.4385	0.4119
	0.4342	0.4028		0.4430	0.4212
	0.4403	0.4049		0.4496	0.4236
	0.4359	0.3960		0.4449	0.4141
V8	0.4359	0.3960	VG	0.4449	0.4141
	0.4403	0.4049		0.4496	0.4236
	0.4465	0.4071		0.4562	0.4260
	0.4418	0.3981		0.4513	0.4164



d) Chromaticity Region & Coordinates

Region	CIE x	CIE y	Region	CIE x	CIE y
U rank (3500 K)					
U1	0.3889	0.3690	U9	0.3941	0.3848
	0.3915	0.3768		0.3968	0.3930
	0.3981	0.3800		0.4040	0.3966
	0.3953	0.3720		0.4010	0.3882
U2	0.3953	0.3720	UA	0.4010	0.3882
	0.3981	0.3800		0.4040	0.3966
	0.4048	0.3832		0.4113	0.4001
	0.4017	0.3751		0.4080	0.3916
U3	0.4017	0.3751	UB	0.4080	0.3916
	0.4048	0.3832		0.4113	0.4001
	0.4116	0.3865		0.4186	0.4037
	0.4082	0.3782		0.4150	0.3950
U4	0.4082	0.3782	UC	0.4150	0.3950
	0.4116	0.3865		0.4186	0.4037
	0.4183	0.3898		0.4259	0.4073
	0.4147	0.3814		0.4221	0.3984
U5	0.3915	0.3768	UD	0.3968	0.3930
	0.3941	0.3848		0.3996	0.4015
	0.4010	0.3882		0.4071	0.4052
	0.3981	0.3800		0.4040	0.3966
U6	0.3981	0.3800	UE	0.4040	0.3966
	0.4010	0.3882		0.4071	0.4052
	0.4080	0.3916		0.4146	0.4089
	0.4048	0.3832		0.4113	0.4001
U7	0.4048	0.3832	UF	0.4113	0.4001
	0.4080	0.3916		0.4146	0.4089
	0.4150	0.3950		0.4222	0.4127
	0.4116	0.3865		0.4186	0.4037
U8	0.4116	0.3865	UG	0.4186	0.4037
	0.4150	0.3950		0.4222	0.4127
	0.4221	0.3984		0.4299	0.4165
	0.4183	0.3898		0.4259	0.4073

Region	CIE x	CIE y	Region	CIE x	CIE y
T rank (4000 K)					
T1	0.3670	0.3578	T9	0.3702	0.3722
	0.3726	0.3612		0.3763	0.3760
	0.3744	0.3685		0.3782	0.3837
	0.3686	0.3649		0.3719	0.3797
T2	0.3726	0.3612	TA	0.3763	0.3760
	0.3783	0.3646		0.3825	0.3798
	0.3804	0.3721		0.3847	0.3877
	0.3744	0.3685		0.3782	0.3837
T3	0.3783	0.3646	TB	0.3825	0.3798
	0.3840	0.3681		0.3887	0.3836
	0.3863	0.3758		0.3912	0.3917
	0.3804	0.3721		0.3847	0.3877
T4	0.3840	0.3681	TC	0.3887	0.3837
	0.3898	0.3716		0.3950	0.3875
	0.3924	0.3794		0.3978	0.3958
	0.3863	0.3758		0.3912	0.3917
T5	0.3686	0.3649	TD	0.3719	0.3797
	0.3744	0.3685		0.3782	0.3837
	0.3763	0.3760		0.3802	0.3916
	0.3702	0.3722		0.3736	0.3874
T6	0.3744	0.3685	TE	0.3782	0.3837
	0.3804	0.3721		0.3847	0.3877
	0.3825	0.3798		0.3869	0.3958
	0.3763	0.3760		0.3802	0.3916
T7	0.3804	0.3721	TF	0.3847	0.3877
	0.3863	0.3758		0.3912	0.3917
	0.3887	0.3836		0.3937	0.4001
	0.3825	0.3798		0.3869	0.3958
T8	0.3863	0.3758	TG	0.3912	0.3917
	0.3924	0.3794		0.3978	0.3958
	0.3950	0.3875		0.4006	0.4044
	0.3887	0.3836		0.3937	0.4001

d) Chromaticity Region & Coordinates

Region	CIE x	CIE y	Region	CIE x	CIE y	Region	CIE x	CIE y
R rank (5000 K)			Q rank (5700 K)			P rank (6500 K)		
R1	0.3371	0.3490	Q1	0.3215	0.3350	P1	0.3068	0.3113
	0.3451	0.3554		0.3290	0.3417		0.3144	0.3186
	0.3440	0.3427		0.3290	0.3300		0.3130	0.3290
	0.3366	0.3369		0.3222	0.3243		0.3048	0.3207
R2	0.3451	0.3554	Q2	0.3290	0.3417	P2	0.3144	0.3186
	0.3533	0.3620		0.3371	0.3490		0.3221	0.3261
	0.3515	0.3487		0.3366	0.3369		0.3213	0.3373
	0.3440	0.3427		0.3290	0.3300		0.3130	0.3290
R3	0.3376	0.3616	Q3	0.3207	0.3462	P3	0.3048	0.3207
	0.3463	0.3687		0.3290	0.3538		0.3130	0.3290
	0.3451	0.3554		0.3290	0.3417		0.3115	0.3391
	0.3371	0.3490		0.3215	0.3350		0.3028	0.3304
R4	0.3463	0.3687	Q4	0.3290	0.3538	P4	0.3130	0.3290
	0.3551	0.3760		0.3376	0.3616		0.3213	0.3373
	0.3533	0.3620		0.3371	0.3490		0.3205	0.3481
	0.3451	0.3554		0.3290	0.3417		0.3115	0.3391

e) MacAdam 3-step Ellipse ($I_F = 350 \text{ mA}$, $T_j = 85 \text{ }^\circ\text{C}$)

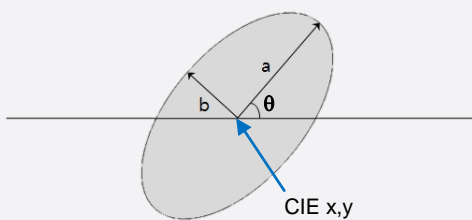

Nom. CCT (K)	Color Rank	Center		Rotation Angle θ ($^\circ$)	a	b
		CIE x	CIE y			
2700	WM	0.4578	0.4101	53.70	0.0081	0.0042
3000	VM	0.4338	0.4030	53.22	0.0083	0.0041
3500	UM	0.4073	0.3917	54.00	0.0093	0.0041
4000	TM	0.3818	0.3797	53.72	0.0094	0.0040

Note:

Samsung maintains measurement tolerance of: $C_x, C_y = \pm 0.005$

3. Typical Characteristics Graphs

a) Spectrum Distribution ($I_f = 350 \text{ mA}$, $T_j = 85 \text{ }^\circ\text{C}$)

Cool White (CRI70)

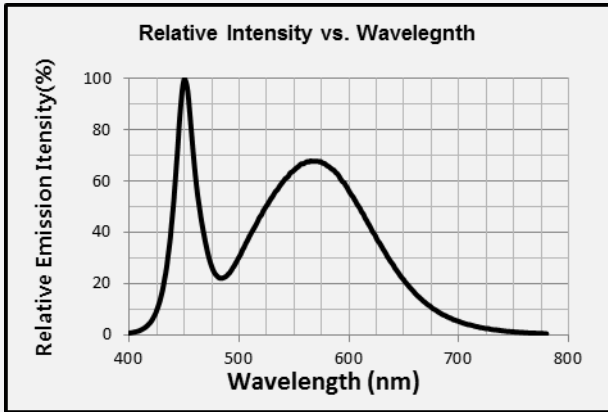

Warm White (CRI80)

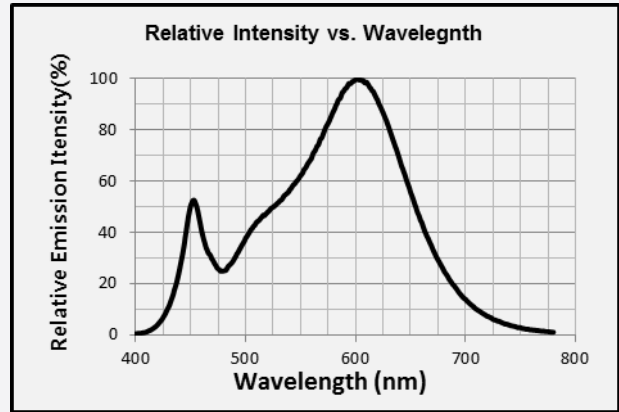

Warm White (CRI90)

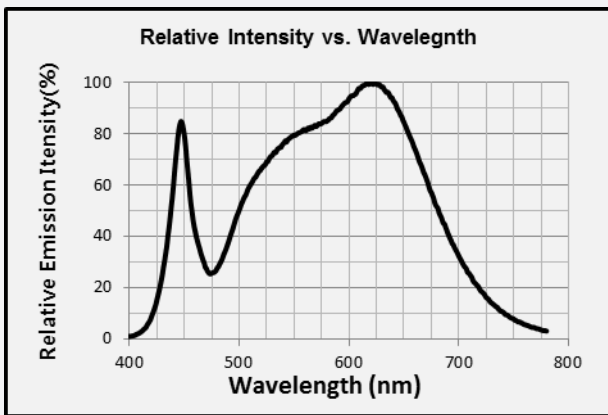

b) Forward Current Characteristics ($T_j = 85 \text{ }^\circ\text{C}$)

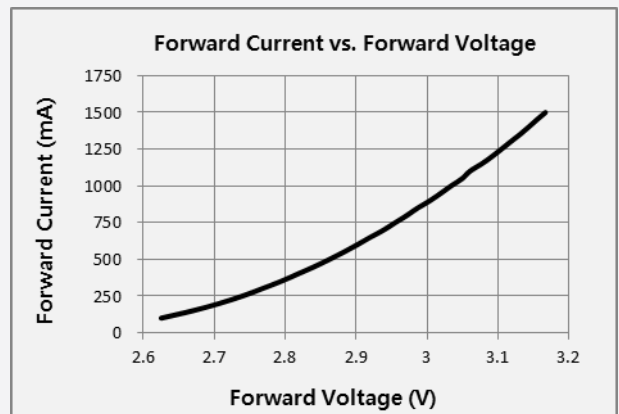
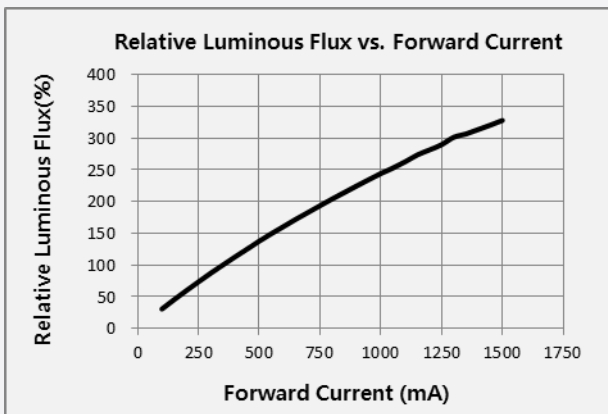

c) Temperature Characteristics ($I_F = 350 \text{ mA}$)

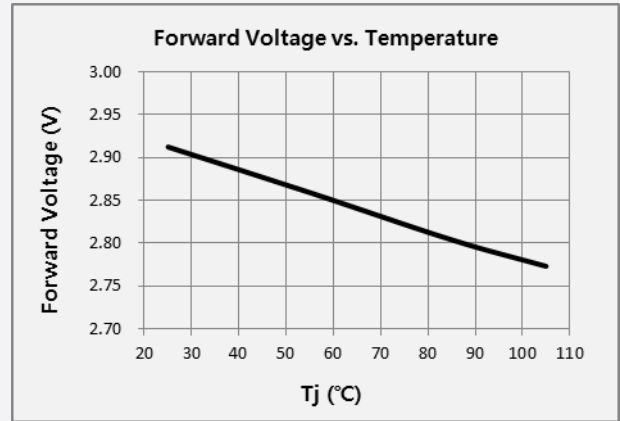
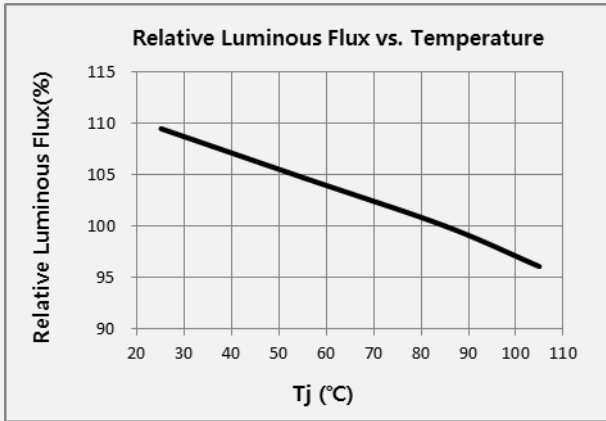

d) Color Shift Characteristics ($I_F = 350 \text{ mA}$, $T_j = 85 \text{ °C}$)

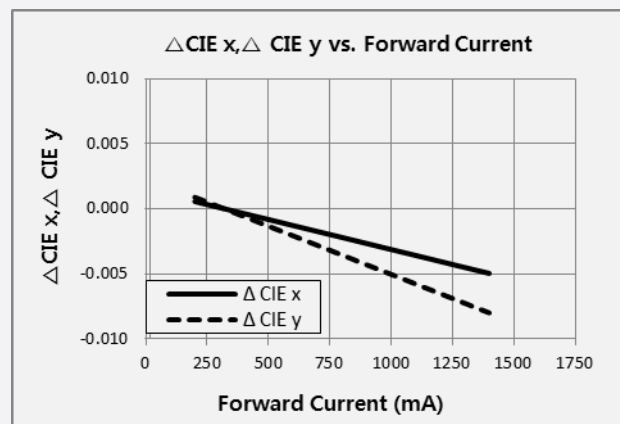
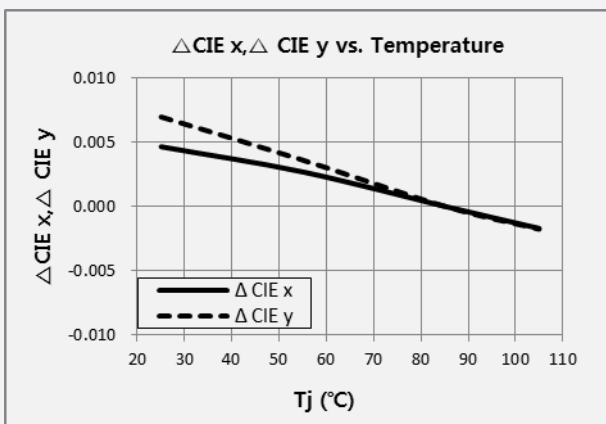

e) Derating Curve and Beam Angle Characteristics ($I_F = 350 \text{ mA}$, $T_j = 25 \text{ °C}$)

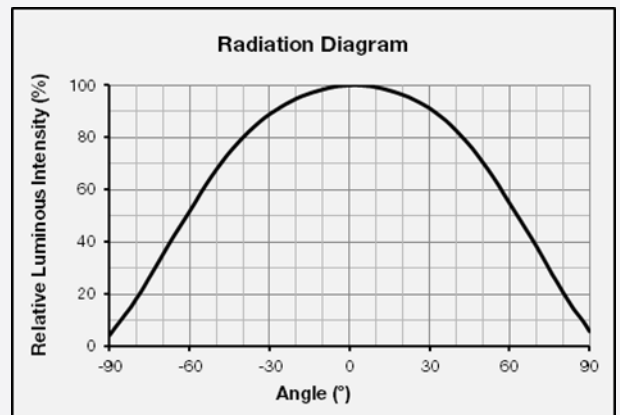
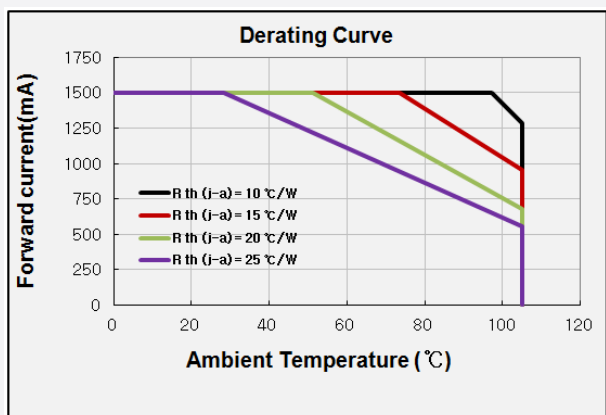

4. Outline Drawing & Dimension

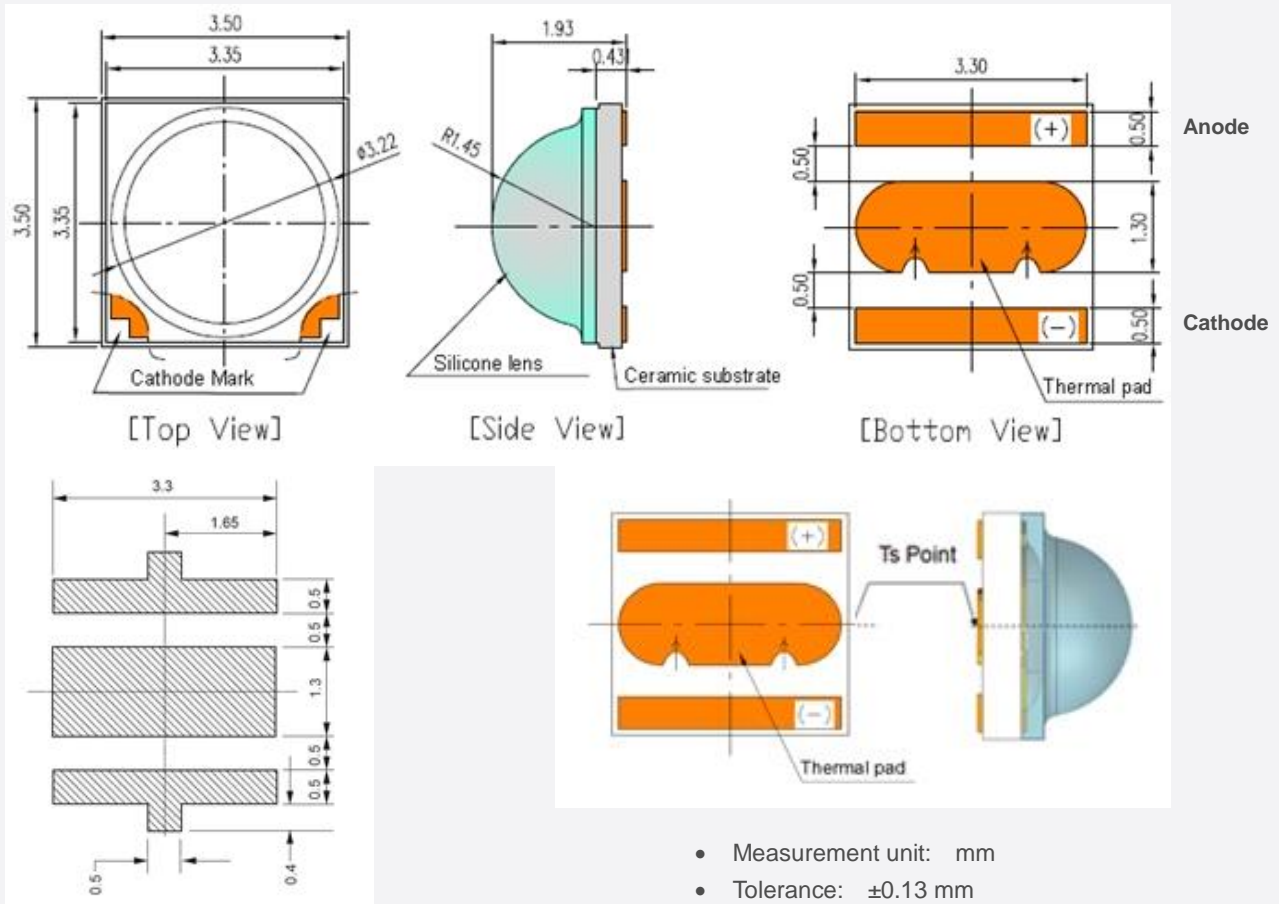

Recommended Soldering Pattern

Notes:

- 1) This LED has built-in ESD protection device(s) connected in parallel to LED chip(s).
- 2) The thermal pad is electrically isolated from the anode and cathode contact pads.
- 3) T_s point and measurement method:
 - ① Measure the nearest point to thermal pad as shown above. If necessary, remove PSR of PCB to reach T_s point.
 - ② All pads must be soldered to the PCB to dissipate heat properly, otherwise the LED can be damaged.

Precautions:

- 1) Pressure on the LEDs will influence to the reliability of the LEDs. Precautions should be taken to avoid strong pressure on the LEDs. Do not put stress on the LEDs during heating.
- 2) Re-soldering should not be done after the LEDs have been soldered. If re-soldering is unavoidable, LED's characteristics should be carefully checked before and after such repair.
- 3) Do not stack assembled PCBs together. Since materials of LEDs is soft, abrasion between two PCB assembled with LED might cause catastrophic failure of the LEDs.

5. Reliability Test Items & Conditions

a) Test Items

Test Item	Test Condition	Test Hour / Cycle	Sample Size
Room Temperature Life Test	25 °C, DC 1000 mA	1000 h	22
High Temperature Life Test	85 °C, DC 1000 mA	1000 h	22
High Temperature Humidity Life Test	85 °C, 85 % RH, DC 1000 mA	1000 h	22
Low Temperature Life Test	-40 °C, DC 1000 mA	1000 h	22
Temperature Humidity Cycle Test	-10 °C ↔ 25 °C 95 % RH ↔ 65 °C 95 % RH DC 1000 mA, 24 h / 1 cycle	10 cycles	11
Powered Temperature Cycle Test	-40 °C / 85 °C each 20 min, 100 min transfer power on/off each 5 min, DC 1000 mA	100 cycles	11
Thermal Shock	-45 °C / 15 min ↔ 125 °C / 15 min temperature change within 5 min	500 cycles	100
High Temperature Storage	120 °C	1000 h	11
Low Temperature Storage	-40 °C	1000 h	11
ESD (HBM)	<p> R₁: 10 MΩ R₂: 1.5 kΩ C: 100 pF V: ±5 kV </p>	5 times	30
ESD (MM)		R ₁ : 10 MΩ R ₂ : 0 C: 200 pF V: ±0.5 kV	5 times
Vibration Test	20~2000~20 Hz, 200 m/s ² , sweep 4 min X, Y, Z 3 direction, each 1 cycle	4 cycles	11
Mechanical Shock Test	1500 g, 0.5 ms 3 shocks each X-Y-Z axis	5 cycles	11

b) Criteria for Judging the Damage

Item	Symbol	Test Condition (T _J = 25 °C)	Limit	
			Min.	Max.
Forward Voltage	V _F	I _F = 350 mA	Init. Value * 0.9	Init. Value * 1.1
Luminous Flux	Φ _v	I _F = 350 mA	Init. Value * 0.7	Init. Value * 1.1

6. Soldering Conditions

a) Reflow Conditions (Pb free)

Reflow frequency: 2 times max.

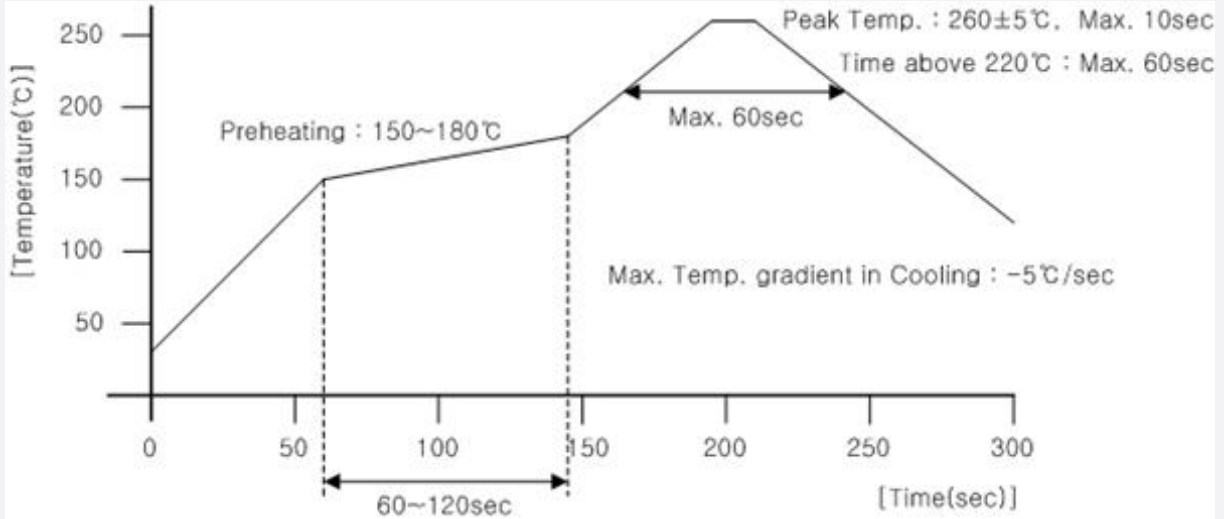

b) Manual Soldering Conditions

Not more than 5 seconds @ max. 300 °C, under soldering iron.

7. Tape & Reel

a) Taping Dimension

(unit: mm)

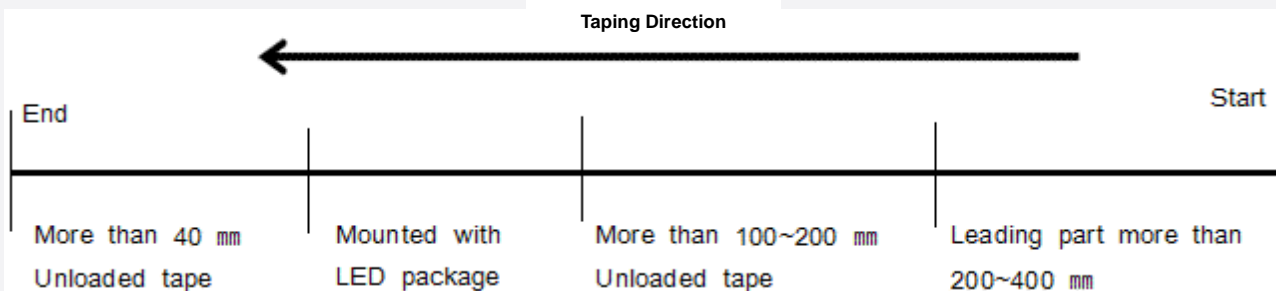
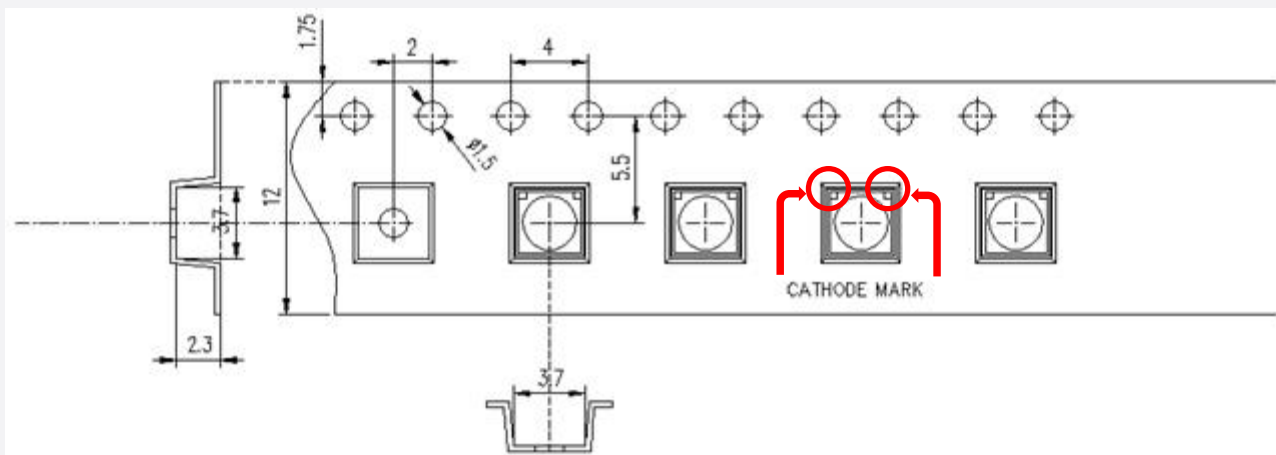

b) Reel Dimension

(unit: mm)

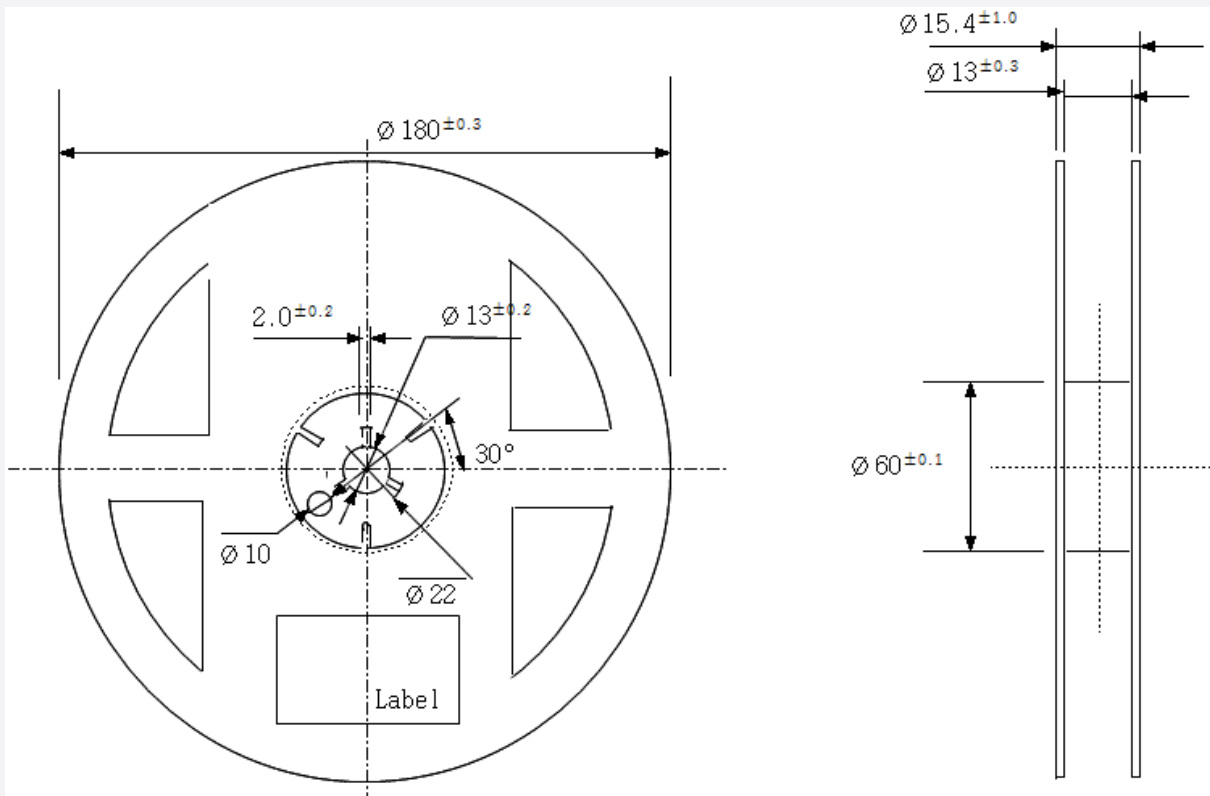
**Notes:**

- 1) Quantity: The quantity/reel is 1,000 pcs
- 2) Cumulative tolerance: Cumulative tolerance / 10 pitches is ± 0.2 mm
- 3) Adhesion strength of cover tape: Adhesion strength is 0.1-0.7 N when the cover tape is turned off from the carrier tape at 10° angle to the carrier tape
- 4) Packaging: P/N, Manufacturing data code no. and quantity are indicated on the aluminum packing bag

8. Label Structure

a) Label Structure

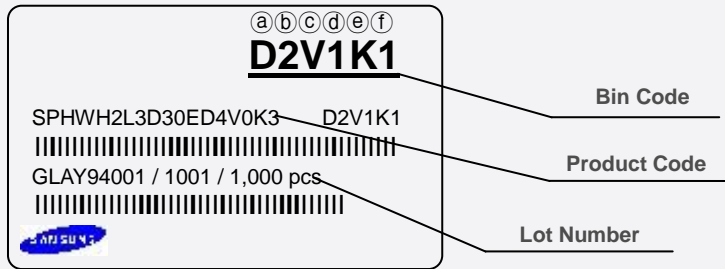

Note: Denoted bin code and product code above is only an example (see description on page 7)

Bin Code:

- ⒶⒷ: Forward Voltage bin (refer to page 13)
- ⒸⒹ: Chromaticity bin (refer to page 14-17)
- ⒺⒻ: Luminous Flux bin (refer to page 8-10)

b) Lot Number

The lot number is composed of the following characters:

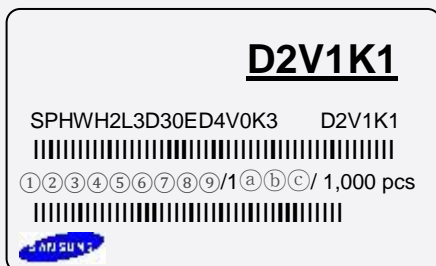

①②③④⑤⑥⑦⑧⑨ / 1ⒶⒷⒸ / 1,000 pcs

- ① : Production site (S: Giheung, Korea, G: Tianjin, China)
- ② : L (LED)
- ③ : Product state (A: Normal, B: Bulk, C: First Production, R: Reproduction, S: Sample)
- ④ : Year (Y: 2014, Z: 2015, A: 2016, ...)
- ⑤ : Month (1~9, A, B, C)
- ⑥ : Day (1~9, A, B~V)
- ⑦⑧⑨ : Product serial number (001 ~ 999)
- ⒶⒷⒸ : Reel number (001 ~ 999)

9. Packing Structure

a) Packing Process

Reel

D2V1K1

SPHWH2L3D30ED4V0K3 D2V1K1
 |||
 GLAY94001 / 1001 / 1,000 pcs
 |||

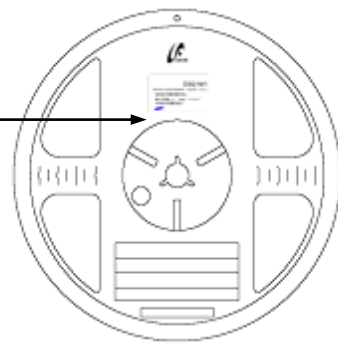
Aluminum Vinyl Packing Bag

D2V1K1

SPHWH2L3D30ED4V0K3 D2V1K1
 |||
 GLAY94001 / 1001 / 1,000 pcs
 |||





Outer Box

Material: Paper SW(B)

Type	Size (mm)			Note
	(a)	(b)	(c)	
7 inch	245 ± 5	220 ± 5	182 ± 5	Up to 7 reels

D2V1K1

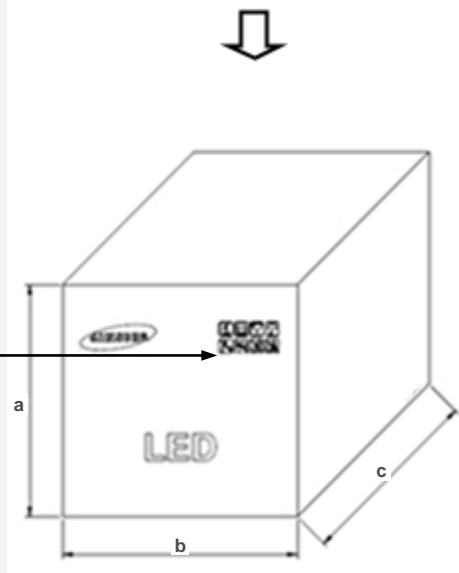
SPHWH2L3D30ED4V0K3 D2V1K1
 |||
 GLAY94001 / 1001 / 7,000 pcs
 |||

b) Aluminum Vinyl Packing Bag



CAUTION

This bag contains
MOISTURE SENSITIVE DEVICES

LEVEL
2a

1. Shelf life in sealed bag: 12 months at <40°C and <90% relative humidity (RH)
2. Peak package body temperature: 240 °C
3. After this bag is opened, devices that will be subjected to reflow solder or other high temperature processes must be:
 - a. Mounted within 672 hours at factory conditions of equal to or less than 30°C /60% RH, or
 - b. Stored at <10% RH
4. Devices require bake, before mounting, if:
 - a. Humidity Indicator Card is >65% when read at 23±5°C, or
 - b. 2a is not met.
5. If baking is required, devices must be baked for 1 hours at 60±5°C



Note: If device containers cannot be subjected to high temperature or shorter bake times are desired, reference IPC/JEDEC J-STD-033 for bake procedure.

Bag seal due date: _____
(if blank, see code label)

Note: Level and body temperature by IPC/JEDEC J-STD-020

D2V1K1

SPHWH2L3D30ED4V0K3 D2V1K1
 |||||
 GLAY94001 / 1001 / 1,000 pcs
 |||||

ATTENTION

OBSEVE PRECAUTIONS
FOR HANDLING
ELECTROSTATIC
SENSITIVE
DEVICES



주의 사항

이 알루미늄 지퍼 백은 습기 및 정전기로부터 제품을 보호하기 위하여 제작되었습니다. 개봉 후에는 즉시 솔더 작업을 실시하는 것을 권장합니다.

습기 및 정전기로부터 제품을 보호 하기 위해서 개봉 후 사용하지 않는 자재는 본 팩에 넣어 보관 하시기 바랍니다. 사용하지 않는 자재를 본 팩에 넣을 때는 반드시 동봉된 드라이 팩과 함께 넣고 지퍼부분을 완전하게 밀봉하여 주시기 바랍니다.

Important

This Al Zipper bag is designed to protect the enclosed products from moisture and ESD. Once opened, the products should be soldered onto the printed circuit board immediately. When not in use, please do not leave the products unprotected by the Al Zipper Bag. To repack unused products., please ensure the zip-lock is completely sealed with the dry pack left inside.

c) Silica Gel & Humidity Indicator Card inside Aluminum Vinyl Bag

DESICCANT
SILICA
DO NOT
DE
SIL

HUMISAFE™

10% 20% 30% 40% 50% 60%



READ AT TOP OF GREEN COLOR
CHANGE BETWEEN YELLOW AND GREEN

**HUMIDITY INDICATOR
COBALT-FREE**

Warning if Green
Change Desiccant

GP&E Co., Ltd.
6CF-60NS

10. Precautions in Handling & Use

- 1) For over-current protection, users are recommended to apply resistors connected in series with the LEDs to mitigate sudden change of the forward current caused by shift of forward voltage.
- 2) This device should not be used in any type of fluid such as water, oil, organic solvent, etc. When cleaning is required, IPA is recommended as the cleaning agent. Some solvent-based cleaning agent may damage the silicone resins used in the device.
- 3) When the device is in operation, the forward current should be carefully determined considering the maximum ambient temperature and corresponding junction temperature.
- 4) LEDs must be stored in a clean environment. If the LEDs are to be stored for three months or more after being shipped from Samsung, they should be packed with a nitrogen-filled container (shelf life of sealed bags is 12 months at temperature 0~40 °C, 0~90 % RH).
- 5) After storage bag is opened, device subjected to soldering, solder reflow, or other high temperature processes must be:
 - a. Mounted within 672 hours (28 days) at an assembly line with a condition of no more than 30 °C / 60 % RH, or
 - b. Stored at <10 % RH
- 6) Repack unused devices with anti-moisture packing, fold to close any opening and then store in a dry place.
- 7) Devices require baking before mounting, if humidity card reading is >60 % at 23 ± 5 °C.
- 8) Devices must be baked for 1 hour at 60 ± 5 °C, if baking is required.
- 9) The LEDs are sensitive to the static electricity and surge current. It is recommended to use a wrist band or anti-electrostatic glove when handling the LEDs. If voltage exceeding the absolute maximum rating is applied to LEDs, it may cause damage or even destruction to LED devices. Damaged LEDs may show some unusual characteristics such as increase in leakage current, lowered turn-on voltage, or abnormal lighting of LEDs at low current.
- 10) VOCs (Volatile Organic Compounds) can be generated from adhesives, flux, hardener or organic additives used in luminaires (fixtures). Transparent LED silicone encapsulant is permeable to those chemicals and they may lead to a discoloration of encapsulant when they exposed to heat or light. This phenomenon can cause a significant loss of light emitted (output) from the luminaires. In order to prevent these problems, we recommend users to know the physical properties of materials used in luminaires and they must be carefully selected.

Legal and additional information.

[About Samsung Electronics Co., Ltd.](#)

Samsung Electronics Co., Ltd. inspires the world and shapes the future with transformative ideas and technologies, redefining the worlds of TVs, smartphones, wearable devices, tablets, cameras, digital appliances, printers, medical equipment, network systems and semiconductors.

We are also leading in the Internet of Things space through, among others, our Digital Health and Smart Home initiatives. We employ 307,000 people across 84 countries. To discover more, please visit our official website at www.samsung.com and our official blog at global.samsungtomorrow.com.

Copyright © 2016 Samsung Electronics Co., Ltd. All rights reserved.

Samsung is a registered trademark of Samsung Electronics Co., Ltd.

Specifications and designs are subject to change without notice. Non-metric weights and measurements are approximate. All data were deemed correct at time of creation. Samsung is not liable for errors or omissions. All brand, product, service names and logos are trademarks and/or registered trademarks of their respective owners and are hereby recognized and acknowledged.

Samsung Electronics Co., Ltd.

1, Samsung ro

Giheung-gu

Yongin-si, Gyeonggi-do, 17113

KOREA

www.samsungled.com

